



SY7208/SY7208B

High Efficiency 1MHz, 2A Step Up Regulator

General Description

The SY7208 and SY7208B are high efficiency boost regulators targeted for general step-up applications. SY7208B incorporates input over-voltage protection and turn off the regulator when the input voltage exceeds 7V.

Ordering Information

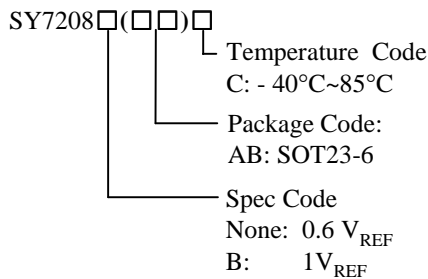

Features

- Wide input range: 3-25V bias input, 25V_{out} max
- 1MHz switching frequency
- Minimum on time: 100ns typical
- Minimum off time: 100ns typical
- Low R_{dson}: 0.2ohm
- Programmable softstart: SY7208B
- 7V input OVP protection: SY7208B
- RoHS Compliant and Halogen Free
- Accurate Reference:
 - o SY7208, 0.6V_{REF}
 - o SY7208B: 1V_{REF}
- Compact package: SOT23 6 pins

Applications

- WLED Drivers
- Networking cards powered from PCI or PCI-express slots

Typical Applications

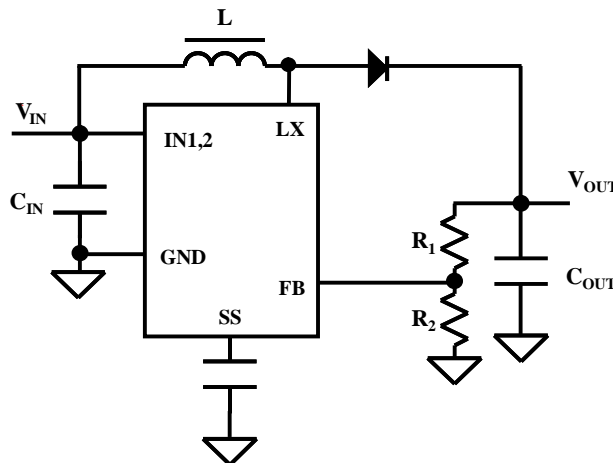
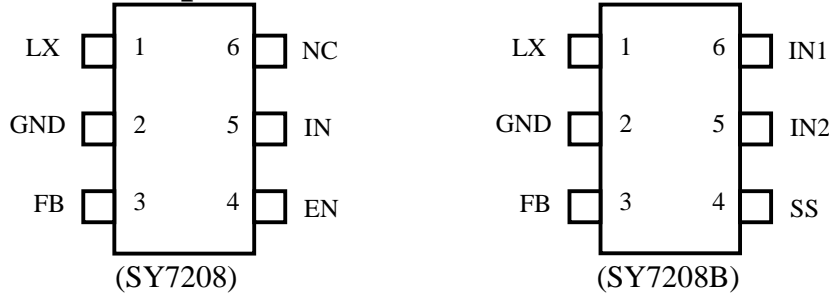

Fig. 1 Typical Schematic Diagram



SY7208/SY7208B

Pinout (SOT23-6 top view)



Top Mark: CAxyz for SY7208 BLxyz for SY7208B

(Device code: CA for SY7208 and BL for SY7208B, x=year code, y=week code, z=lot number code)

Pin Name	SOT23-6	Pin Description
IN(SY7208)	5	Input pin. Decouple this pin to GND pin with 1uF ceramic cap.
IN1,2(SY7208B)	6,5	Input pins. Decouple this pin to GND pin with 1uF ceramic cap.
GND	2	Ground pin
LX	1	Inductor node. Connect an inductor between IN pin and LX pin.
FB	3	Feedback pin. Connect a resistor R1 between V _{OUT} and FB, and a resistor R2 between FB and GND to program the output voltage: V _{OUT} =0.6V*(R1/R2+1)—SY7208; V _{OUT} =1V*(R1/R2+1)—SY7208B.
SS (SY7208B)	4	External softstart pin. Add a capacitor to this pin to program the softstart time to limit the inrush current. For SY7208B, pull this pin to IN can disable the input OVP.
EN (SY7208)	4	Enable control. High to turn on the part. Don't leave it floated.

Absolute Maximum Ratings (Note 1)

OUT, LX, IN, SEN	26V
All other pins	6V
Power Dissipation, P _D @ T _A = 25°C SOT-23-6,	0.4W
Package Thermal Resistance (Note 2)	
θ _{JA}	250°C/W
θ _{JC}	130°C/W
Junction Temperature Range	150°C
Lead Temperature (Soldering, 10 sec.)	260°C
Storage Temperature Range	-65°C to 150°C
ESD Susceptibility (Note 2)	
HBM (Human Body Mode)	2kV
MM (Machine Mode)	200V

Recommended Operating Conditions (Note 3)

IN1,2, LX	3V to 25V
All other pins	0-5.5V
Junction Temperature Range	-40°C to 125°C
Ambient Temperature Range	-40°C to 85°C



SY7208/SY7208B

Electrical Characteristics

(VIN = 5V, Vout=12V, Iout=100mA, TA = 25°C unless otherwise specified)

Parameter	Symbol	Test Conditions	Min	Typ	Max	Unit
Input Voltage Range	VIN		3		25	V
Quiescent Current	IQ	FB=0.66V		100		μA
Shutdown Current (SY7208 only)	ISHDN	SY7208: EN=0		1	5	μA
Low Side Main FET RON	RDS(ON)1			200		mΩ
Main FET Current Limit	ILIMI		2		2.6	A
Switching Frequency	Fsw		0.8	1	1.2	MHz
Feedback Reference Voltage	VREF	SY7208	0.588	0.6	0.612	V
		SY7208B	0.98	1	1.02	V
IN OVP rising threshold	VIN,OV	SY7208B only	7			V
IN OVP hysteresis	VOV,HYS	SY7208B only		0.3		V
IN UVLO rising threshold	VIN,UVLO				2.7	V
UVLO hysteresis	UVLO,HYS			0.1		V
Thermal Shutdown Temperature	TSD			150		°C

Note 1: Stresses listed as the above “Absolute Maximum Ratings” may cause permanent damage to the device. These are for stress ratings. Functional operation of the device at these or any other conditions beyond those indicated in the operational sections of the specifications is not implied. Exposure to absolute maximum rating conditions for extended periods may remain possibility to affect device reliability.

Note 2: θJA is measured in the natural convection at TA = 25°C on a low effective single layer thermal conductivity test board of JEDEC 51-3 thermal measurement standard.

Note 3: The device is not guaranteed to function outside its operating conditions.



SY7208/SY7208B

SOT23-6 Package outline & PCB layout design

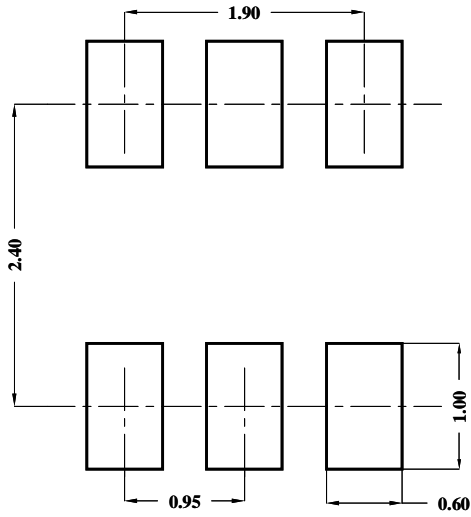

Recommended Pad Layout

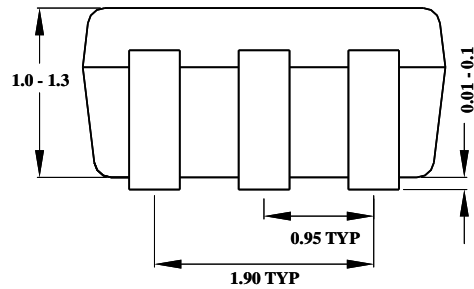
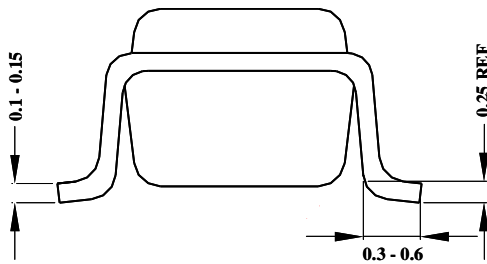
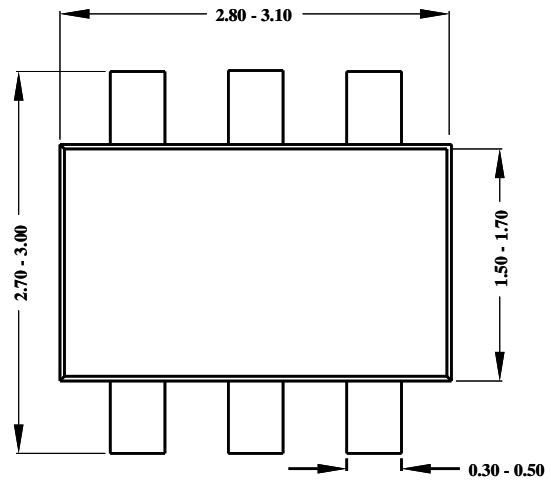

Notes: All dimensions are in millimeters.
All dimensions don't include mold flash & metal burr.