

## 0.03- $\mu\text{V}/^\circ\text{C}$ Drift, Low-Noise, Rail-to-Rail Output, 36-V, Zero-Drift OPERATIONAL AMPLIFIERS

Check for Samples: [OPA188](#), [OPA2188](#), [OPA4188](#)

### FEATURES

- **Low Offset Voltage:** 25  $\mu\text{V}$  (max)
- **Zero-Drift:** 0.03  $\mu\text{V}/^\circ\text{C}$
- **Low Noise:** 8.8  $\text{nV}/\sqrt{\text{Hz}}$   
0.1-Hz to 10-Hz Noise: 0.25  $\mu\text{V}_{\text{PP}}$
- **Excellent DC Precision:**  
PSRR: 142 dB  
CMRR: 146 dB  
Open-Loop Gain: 136 dB
- **Gain Bandwidth:** 2 MHz
- **Quiescent Current:** 475  $\mu\text{A}$  (max)
- **Wide Supply Range:**  $\pm 2\text{ V}$  to  $\pm 18\text{ V}$
- **Rail-to-Rail Output:**  
Input Includes Negative Rail
- **RFI Filtered Inputs**
- **MicroSIZE Packages**

### APPLICATIONS

- **Bridge Amplifiers**
- **Strain Gauges**
- **Test Equipment**
- **Transducer Applications**
- **Temperature Measurement**
- **Electronic Scales**
- **Medical Instrumentation**
- **Resistor Thermal Detectors**
- **Precision Active Filters**

### DESCRIPTION

The OPAx188 series operational amplifiers use TI proprietary auto-zeroing techniques to provide low offset voltage (25  $\mu\text{V}$ , max), and near zero-drift over time and temperature. These miniature, high-precision, low quiescent current amplifiers offer high input impedance and rail-to-rail output swing within 15 mV of the rails. The input common-mode range includes the negative rail. Either single or dual supplies can be used in the range of +4.0 V to +36 V ( $\pm 2\text{ V}$  to  $\pm 18\text{ V}$ ).

The single version is available in the *MicroSIZE* SOT23-5, MSOP-8, and SO-8 packages; the dual is offered in MSOP-8 and SO-8 packages; the quad is offered in SO-14 and TSSOP-14 packages. All versions are specified for operation from  $-40^\circ\text{C}$  to  $+105^\circ\text{C}$ .

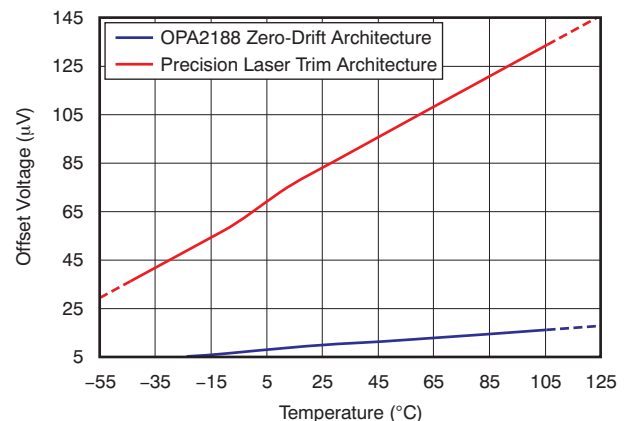

### Zero-Drift Amplifier Portfolio

VERSION	PRODUCT	OFFSET VOLTAGE ( $\mu\text{V}$ )	OFFSET VOLTAGE DRIFT ( $\mu\text{V}/^\circ\text{C}$ )	BANDWIDTH (MHz)
Single	OPA188 (4 V to 36 V)	25	0.085	2
Single	OPA333 (5 V)	10	0.05	0.35
	OPA378 (5 V)	50	0.25	0.9
	OPA735 (12 V)	5	0.05	1.6
Dual	OPA2188 (4 V to 36 V)	25	0.085	2
	OPA2333 (5 V)	10	0.05	0.35
	OPA2378 (5 V)	50	0.25	0.9
	OPA2735 (12 V)	5	0.05	1.6
Quad	OPA4188 (4 V to 36 V)	25	0.085	2
Quad	OPA4330 (5 V)	50	0.25	0.35



Please be aware that an important notice concerning availability, standard warranty, and use in critical applications of Texas Instruments semiconductor products and disclaimers thereto appears at the end of this data sheet.

All trademarks are the property of their respective owners.

UNLESS OTHERWISE NOTED this document contains PRODUCTION DATA information current as of publication date. Products conform to specifications per the terms of Texas Instruments standard warranty. Production processing does not necessarily include testing of all parameters.

Copyright © 2011, Texas Instruments Incorporated



This integrated circuit can be damaged by ESD. Texas Instruments recommends that all integrated circuits be handled with appropriate precautions. Failure to observe proper handling and installation procedures can cause damage.

ESD damage can range from subtle performance degradation to complete device failure. Precision integrated circuits may be more susceptible to damage because very small parametric changes could cause the device not to meet its published specifications.

### PACKAGE INFORMATION<sup>(1)</sup>

PRODUCT	PACKAGE-LEAD	PACKAGE DESIGNATOR	SPECIFIED TEMPERATURE RANGE	PACKAGE MARKING	ORDERING NUMBER	TRANSPORT MEDIA, QUANTITY
<b>SINGLE</b>						
OPA188 <sup>(2)</sup>	SOT23-5	DBV	–40°C to +105°C	TBD	OPA188AIDBVT	Tape and Reel, 250
					OPA188AIDBVR	Tape and Reel, 3000
	SO-8	D	–40°C to +105°C	OPA188A	OPA188AID	Rails, 100
					OPA188AIDR	Tape and Reel, 2500
	MSOP-8	DGK	–40°C to +105°C	TBD	OPA188AIDGKT	Tape and Reel, 250
					OPA188AIDGKR	Tape and Reel, 2500
<b>DUAL</b>						
OPA2188	SO-8	D	–40°C to +105°C	2188	OPA2188AID	Rails, 100
					OPA2188AIDR	Tape and Reel, 2500
	MSOP-8	DGK	–40°C to +105°C	2188	OPA2188AIDGKT	Tape and Reel, 250
					OPA2188AIDGKR	Tape and Reel, 2500
<b>QUAD</b>						
OPA4188 <sup>(2)</sup>	SO-14	D	–40°C to +105°C	OPA4188A	OPA4188AID	Rails, 90
					OPA4188AIDR	Tape and Reel, 2000
	TSSOP-14	PW	–40°C to +105°C	OPA4188A	OPA4188AIPW	Rails, 90
					OPA4188AIPWR	Tape and Reel, 2000

(1) For the most current package and ordering information, see the Package Option Addendum at the end of this document, or visit the device product folder at [www.ti.com](http://www.ti.com).

(2) Product preview device.

### ABSOLUTE MAXIMUM RATINGS

		OPAx188	UNIT
Supply voltage		±20, 40 (single supply)	V
Signal input terminals	Voltage	(V–) – 0.5 to (V+) + 0.5	V
	Current <sup>(1)</sup>	±10	mA
Output short-circuit <sup>(2)</sup>		Continuous	
Operating temperature		–55 to +125	°C
Storage temperature		–65 to +150	°C
Junction temperature		+150	°C
ESD ratings	Human body model (HBM)	1.5	kV
	Charged device model (CDM)	1	kV

(1) Stresses above these ratings may cause permanent damage. Exposure to absolute maximum conditions for extended periods may degrade device reliability. These are stress ratings only and functional operation of the device at these or any other conditions beyond those specified is not implied.

(2) Short-circuit to ground, one amplifier per package.

**ELECTRICAL CHARACTERISTICS: High-Voltage Operation**
 $V_S = \pm 4\text{ V to } \pm 18\text{ V}$  ( $V_S = +8\text{ V to } +36\text{ V}$ )

**Boldface** limits apply over the specified temperature range,  $T_A = -40^\circ\text{C to } +105^\circ\text{C}$ .

At  $T_A = +25^\circ\text{C}$ ,  $R_L = 10\text{ k}\Omega$  connected to  $V_S/2$ , and  $V_{\text{COM}} = V_{\text{OUT}} = V_S/2$ , unless otherwise noted.

PARAMETER		CONDITIONS	OPA188, OPA2188, OPA4188			UNIT
			MIN	TYP	MAX	
<b>OFFSET VOLTAGE</b>						
$V_{\text{OS}}$	Input offset voltage			6	25	$\mu\text{V}$
$dV_{\text{OS}}/dT$	<b>vs Temperature</b>			<b>0.03</b>	<b>0.085</b>	$\mu\text{V}/^\circ\text{C}$
PSRR	vs power supply	$V_S = 4\text{ V to } 36\text{ V}$ , $V_{\text{CM}} = V_S/2$		0.075	0.3	$\mu\text{V}/\text{V}$
	<b>vs temperature</b>	<b><math>V_S = 4\text{ V to } 36\text{ V}</math>, <math>V_{\text{CM}} = V_S/2</math></b>			<b>0.3</b>	<b><math>\mu\text{V}/\text{V}</math></b>
	Long-term stability			See note <sup>(1)</sup>		$\mu\text{V}$
	Channel separation, dc			1		$\mu\text{V}/\text{V}$
<b>INPUT BIAS CURRENT</b>						
$I_B$	Input bias current	$V_{\text{CM}} = V_S/2$		$\pm 160$	$\pm 850$	$\text{pA}$
	<b>over temperature</b>	<b><math>-40^\circ\text{C to } +105^\circ\text{C}</math></b>			<b><math>\pm 4</math></b>	<b><math>\text{nA}</math></b>
$I_{\text{OS}}$	Input offset current			$\pm 320$	$\pm 1700$	$\text{pA}$
	<b>over temperature</b>	<b><math>-40^\circ\text{C to } +105^\circ\text{C}</math></b>			<b><math>\pm 2</math></b>	<b><math>\text{nA}</math></b>
<b>NOISE</b>						
$e_n$	Input voltage noise, $f = 0.1\text{ Hz to } 10\text{ Hz}$			0.25		$\mu\text{V}_{\text{PP}}$
$e_n$	Input voltage noise density, $f = 1\text{ kHz}$			8.8		$\text{nV}/\sqrt{\text{Hz}}$
$i_n$	Input current noise density, $f = 1\text{ kHz}$			7		$\text{fA}/\sqrt{\text{Hz}}$
<b>INPUT VOLTAGE RANGE</b>						
$V_{\text{CM}}$	<b>Common-mode voltage range</b>		<b>V–</b>		<b>(V+) – 1.5</b>	<b>V</b>
CMRR	Common-mode rejection ratio	$(V-) < V_{\text{CM}} < (V+) - 1.5\text{ V}$	120	134		$\text{dB}$
		$(V-) + 0.5\text{ V} < V_{\text{CM}} < (V+) - 1.5\text{ V}$ , $V_S = \pm 18\text{ V}$	130	146		$\text{dB}$
	<b>over temperature</b>	<b><math>(V-) + 0.5\text{ V} &lt; V_{\text{CM}} &lt; (V+) - 1.5\text{ V}</math>, <math>V_S = \pm 18\text{ V}</math></b>	<b>120</b>	<b>126</b>		<b><math>\text{dB}</math></b>
<b>INPUT IMPEDANCE</b>						
	Differential			100/6		$\text{M}\Omega/\text{pF}$
	Common-mode			6/9.5		$10^{12}\ \Omega/\text{pF}$
<b>OPEN-LOOP GAIN</b>						
$A_{\text{OL}}$	Open-loop voltage gain	$(V-) + 500\text{ mV} < V_O < (V+) - 500\text{ mV}$ , $R_L = 10\text{ k}\Omega$	130	136		$\text{dB}$
	<b>Open-loop voltage gain</b>	<b><math>(V-) + 500\text{ mV} &lt; V_O &lt; (V+) - 500\text{ mV}</math>, <math>R_L = 10\text{ k}\Omega</math></b>	<b>120</b>	<b>126</b>		<b><math>\text{dB}</math></b>
<b>FREQUENCY RESPONSE</b>						
GBW	Gain-bandwidth product			2		$\text{MHz}$
SR	Slew rate	$G = +1$		0.8		$\text{V}/\mu\text{s}$
	Settling time, 0.1%	$V_S = \pm 18\text{ V}$ , $G = 1$ , 10-V step		20		$\mu\text{s}$
	Settling time, 0.01%	$V_S = \pm 18\text{ V}$ , $G = 1$ , 10-V step		27		$\mu\text{s}$
	Overload recovery time	$V_{\text{IN}} \times G = V_S$		1		$\mu\text{s}$
THD+N	Total harmonic distortion + noise	1 kHz, $G = 1$ , $V_{\text{OUT}} = 1\text{ V}_{\text{rms}}$		0.0001		%

(1) 1000-hour life test at  $+125^\circ\text{C}$  demonstrated randomly distributed variation in the range of measurement limits—approximately  $4\ \mu\text{V}$ .

**ELECTRICAL CHARACTERISTICS: High-Voltage Operation (continued)**

$V_S = \pm 4\text{ V to } \pm 18\text{ V}$  ( $V_S = +8\text{ V to } +36\text{ V}$ )

**Boldface** limits apply over the specified temperature range,  $T_A = -40^\circ\text{C to } +105^\circ\text{C}$ .

At  $T_A = +25^\circ\text{C}$ ,  $R_L = 10\text{ k}\Omega$  connected to  $V_S/2$ , and  $V_{COM} = V_{OUT} = V_S/2$ , unless otherwise noted.

PARAMETER	CONDITIONS	OPA188, OPA2188, OPA4188			UNIT
		MIN	TYP	MAX	
<b>OUTPUT</b>					
Voltage output swing from rail	No load		6	15	mV
	$R_L = 10\text{ k}\Omega$		220	250	mV
<b>Voltage output swing from rail</b>	<b><math>R_L = 10\text{ k}\Omega</math></b>		<b>310</b>	<b>350</b>	<b>mV</b>
$I_{SC}$	Short-circuit current		$\pm 18$		mA
$R_O$	Open-loop output resistance	$f = 1\text{ MHz}$ , $I_O = 0$	120		$\Omega$
$C_{LOAD}$	Capacitive load drive		1		nF
<b>POWER SUPPLY</b>					
$V_S$	Operating voltage range		4 to 36 ( $\pm 2$ to $\pm 18$ )		V
$I_Q$	Quiescent current (per amplifier)	$V_S = \pm 4\text{ V to } V_S = \pm 18\text{ V}$	415	475	$\mu\text{A}$
	<b>over temperature</b>	<b><math>I_O = 0\text{ mA}</math></b>		<b>525</b>	<b><math>\mu\text{A}</math></b>
<b>TEMPERATURE RANGE</b>					
	Specified range		-40	+105	$^\circ\text{C}$
	Operating range		-40	+125	$^\circ\text{C}$
	Storage range		-65	+150	$^\circ\text{C}$

**ELECTRICAL CHARACTERISTICS: Low-Voltage Operation**
 $V_S = \pm 2\text{ V to } < \pm 4\text{ V}$  ( $V_S = +4\text{ V to } < +8\text{ V}$ )

**Boldface** limits apply over the specified temperature range,  $T_A = -40^\circ\text{C to } +105^\circ\text{C}$ .

At  $T_A = +25^\circ\text{C}$ ,  $R_L = 10\text{ k}\Omega$  connected to  $V_S/2$ , and  $V_{\text{COM}} = V_{\text{OUT}} = V_S/2$ , unless otherwise noted.

PARAMETER		CONDITIONS	OPA188, OPA2188, OPA4188			UNIT
			MIN	TYP	MAX	
<b>OFFSET VOLTAGE</b>						
$V_{\text{OS}}$	Input offset voltage			6	25	$\mu\text{V}$
$dV_{\text{OS}}/dT$	<b>vs temperature</b>			<b>0.03</b>	<b>0.085</b>	$\mu\text{V}/^\circ\text{C}$
PSRR	vs power supply	$V_S = 4\text{ V to } 36\text{ V}$ , $V_{\text{CM}} = V_S/2$		0.075	0.3	$\mu\text{V}/\text{V}$
	<b>vs temperature</b>	<b><math>V_S = 4\text{ V to } 36\text{ V}</math>, <math>V_{\text{CM}} = V_S/2</math></b>			<b>0.3</b>	<b><math>\mu\text{V}/\text{V}</math></b>
	Long-term stability			See Note <sup>(1)</sup>		$\mu\text{V}$
	Channel separation, dc			1		$\mu\text{V}/\text{V}$
<b>INPUT BIAS CURRENT</b>						
$I_B$	Input bias current	$V_{\text{CM}} = V_S/2$		$\pm 160$	$\pm 850$	$\text{pA}$
	<b>over temperature</b>	<b><math>-40^\circ\text{C to } +105^\circ\text{C}</math></b>			<b><math>\pm 4</math></b>	<b><math>\text{nA}</math></b>
$I_{\text{OS}}$	Input offset current			$\pm 320$	$\pm 1700$	$\text{pA}$
	<b>over temperature</b>	<b><math>-40^\circ\text{C to } +105^\circ\text{C}</math></b>			<b><math>\pm 2</math></b>	<b><math>\text{nA}</math></b>
<b>NOISE</b>						
$e_n$	Input voltage noise, $f = 0.1\text{ Hz to } 10\text{ Hz}$			0.25		$\mu\text{V}_{\text{PP}}$
	Input voltage noise density, $f = 1\text{ kHz}$			8.8		$\text{nV}/\sqrt{\text{Hz}}$
$i_n$	Input current noise density, $f = 1\text{ kHz}$			7		$\text{fA}/\sqrt{\text{Hz}}$
<b>INPUT VOLTAGE RANGE</b>						
$V_{\text{CM}}$	<b>Common-mode voltage range</b>		<b><math>V^-</math></b>		<b><math>(V^+) - 1.5</math></b>	<b><math>V</math></b>
CMRR	Common-mode rejection ratio	$(V^-) < V_{\text{CM}} < (V^+) - 1.5\text{ V}$	106	114		$\text{dB}$
		$(V^-) + 0.5\text{ V} < V_{\text{CM}} < (V^+) - 1.5\text{ V}$ , $V_S = \pm 2\text{ V}$	114	120		$\text{dB}$
	<b>over temperature</b>	<b><math>(V^-) + 0.5\text{ V} &lt; V_{\text{CM}} &lt; (V^+) - 1.5\text{ V}</math>, <b><math>V_S = \pm 2\text{ V}</math></b></b>	<b>110</b>	<b>120</b>		<b><math>\text{dB}</math></b>
<b>INPUT IMPEDANCE</b>						
	Differential			100/6		$\text{M}\Omega/\text{pF}$
	Common-mode			6/95		$10^{12}\ \Omega/\text{pF}$
<b>OPEN-LOOP GAIN</b>						
$A_{\text{OL}}$	Open-loop voltage gain	$(V^-) + 500\text{ mV} < V_{\text{O}} < (V^+) - 500\text{ mV}$ , $R_L = 5\text{ k}\Omega$ , $V_S = 5\text{ V}$	110	120		$\text{dB}$
		$(V^-) + 500\text{ mV} < V_{\text{O}} < (V^+) - 500\text{ mV}$ , $R_L = 10\text{ k}\Omega$	120	130		$\text{dB}$
	<b>Open-loop voltage gain</b>	<b><math>(V^-) + 500\text{ mV} &lt; V_{\text{O}} &lt; (V^+) - 500\text{ mV}</math>, <b><math>R_L = 10\text{ k}\Omega</math></b></b>	<b>114</b>	<b>120</b>		<b><math>\text{dB}</math></b>
<b>FREQUENCY RESPONSE</b>						
GBW	Gain-bandwidth product			2		$\text{MHz}$
SR	Slew rate	$G = +1$		0.8		$\text{V}/\mu\text{s}$
	Overload recovery time	$V_{\text{IN}} \times G = V_S$		1		$\mu\text{s}$
THD+N	Total harmonic distortion + noise	1 kHz, $G = 1$ , $V_{\text{OUT}} = 1\text{ V}_{\text{rms}}$		0.0001		%

(1) 1000-hour life test at  $+125^\circ\text{C}$  demonstrated randomly distributed variation in the range of measurement limits—approximately  $4\ \mu\text{V}$ .

### ELECTRICAL CHARACTERISTICS: Low-Voltage Operation (continued)

$V_S = \pm 2\text{ V to } < \pm 4\text{ V}$  ( $V_S = +4\text{ V to } < +8\text{ V}$ )

**Boldface** limits apply over the specified temperature range,  $T_A = -40^\circ\text{C to } +105^\circ\text{C}$ .

At  $T_A = +25^\circ\text{C}$ ,  $R_L = 10\text{ k}\Omega$  connected to  $V_S/2$ , and  $V_{COM} = V_{OUT} = V_S/2$ , unless otherwise noted.

PARAMETER	CONDITIONS	OPA188, OPA2188, OPA4188			UNIT
		MIN	TYP	MAX	
<b>OUTPUT</b>					
Voltage output swing from rail	No load		6	15	mV
	$R_L = 10\text{ k}\Omega$		220	250	mV
<b>Voltage output swing from rail</b>	<b><math>R_L = 10\text{ k}\Omega</math></b>		<b>310</b>	<b>350</b>	<b>mV</b>
$I_{SC}$	Short-circuit current		$\pm 18$		mA
$R_O$	Open-loop output resistance	$f = 1\text{ MHz}, I_O = 0$	120		$\Omega$
$C_{LOAD}$	Capacitive load drive		1		nF
<b>POWER SUPPLY</b>					
$V_S$	Operating voltage range		4 to 36 ( $\pm 2$ to $\pm 18$ )		V
$I_Q$	Quiescent current (per amplifier)	$V_S = \pm 2\text{ V to } V_S = \pm 4\text{ V}$	385	440	$\mu\text{A}$
	<b>over temperature</b>	<b><math>I_O = 0\text{ mA}</math></b>		<b>525</b>	<b><math>\mu\text{A}</math></b>
<b>TEMPERATURE RANGE</b>					
	Specified range		-40	+105	$^\circ\text{C}$
	Operating range		-40	+125	$^\circ\text{C}$
	Storage range		-65	+150	$^\circ\text{C}$

### THERMAL INFORMATION: OPA2188

THERMAL METRIC <sup>(1)</sup>		OPA2188ID	OPA2188IDGK	UNITS
		D	DGK	
		8 PINS	8 PINS	
$\theta_{JA}$	Junction-to-ambient thermal resistance	111.0	159.3	$^\circ\text{C/W}$
$\theta_{JCTop}$	Junction-to-case (top) thermal resistance	54.9	37.4	
$\theta_{JB}$	Junction-to-board thermal resistance	51.7	48.5	
$\psi_{JT}$	Junction-to-top characterization parameter	9.3	1.2	
$\psi_{JB}$	Junction-to-board characterization parameter	51.1	77.1	
$\theta_{JCbott}$	Junction-to-case (bottom) thermal resistance	n/a	n/a	

(1) For more information about traditional and new thermal metrics, see the *IC Package Thermal Metrics* application report, [SPRA953](#).

**PIN CONFIGURATIONS**

**OPA188  
D, DGK PACKAGES (SO-8, MSOP-8)  
(TOP VIEW)**

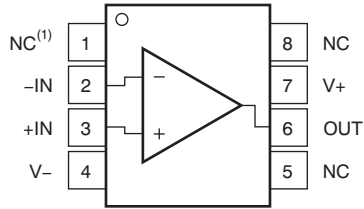

(1) NC = no connection.

**OPA188  
DBV PACKAGE (SOT23-5)  
(TOP VIEW)**

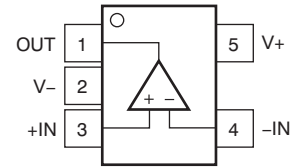

**OPA4188  
D, PW PACKAGES (SO-14, TSSOP-14)  
(TOP VIEW)**

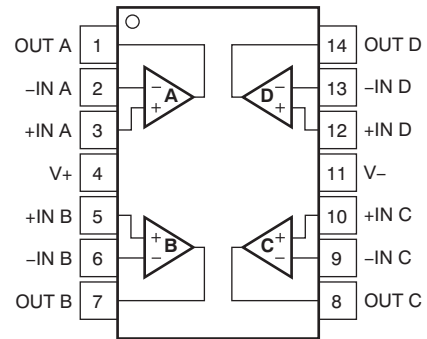

## TYPICAL CHARACTERISTICS

**Table 1. Characteristic Performance Measurements**

DESCRIPTION	FIGURE
Offset Voltage Production Distribution	Figure 1
Offset Voltage Drift Distribution	Figure 2
Offset Voltage vs Temperature	Figure 3
Offset Voltage vs Common-Mode Voltage	Figure 4, Figure 5
Offset Voltage vs Power Supply	Figure 6
$I_B$ and $I_{OS}$ vs Common-Mode Voltage	Figure 7
Input Bias Current vs Temperature	Figure 8
Output Voltage Swing vs Output Current (Maximum Supply)	Figure 9
CMRR and PSRR vs Frequency (Referred-to-Input)	Figure 10
CMRR vs Temperature	Figure 11, Figure 12
PSRR vs Temperature	Figure 13
0.1-Hz to 10-Hz Noise	Figure 14
Input Voltage Noise Spectral Density vs Frequency	Figure 15
THD+N Ratio vs Frequency	Figure 16
THD+N vs Output Amplitude	Figure 17
Quiescent Current vs Supply Voltage	Figure 18
Quiescent Current vs Temperature	Figure 19
Open-Loop Gain and Phase vs Frequency	Figure 20
Closed-Loop Gain vs Frequency	Figure 21
Open-Loop Gain vs Temperature	Figure 22
Open-Loop Output Impedance vs Frequency	Figure 23
Small-Signal Overshoot vs Capacitive Load (100-mV Output Step)	Figure 24, Figure 25
No Phase Reversal	Figure 26
Positive Overload Recovery	Figure 27
Negative Overload Recovery	Figure 28
Small-Signal Step Response (100 mV)	Figure 29, Figure 30
Large-Signal Step Response	Figure 31, Figure 32
Large-Signal Settling Time (10-V Positive Step)	Figure 33
Large-Signal Settling Time (10-V Negative Step)	Figure 34
Short-Circuit Current vs Temperature	Figure 35
Maximum Output Voltage vs Frequency	Figure 36
Channel Separation vs Frequency	Figure 37
EMIRR IN+ vs Frequency	Figure 38



### TYPICAL CHARACTERISTICS

$V_S = \pm 18\text{ V}$ ,  $V_{CM} = V_S/2$ ,  $R_{LOAD} = 10\text{ k}\Omega$  connected to  $V_S/2$ , and  $C_L = 100\text{ pF}$ , unless otherwise noted.

**OFFSET VOLTAGE PRODUCTION DISTRIBUTION**

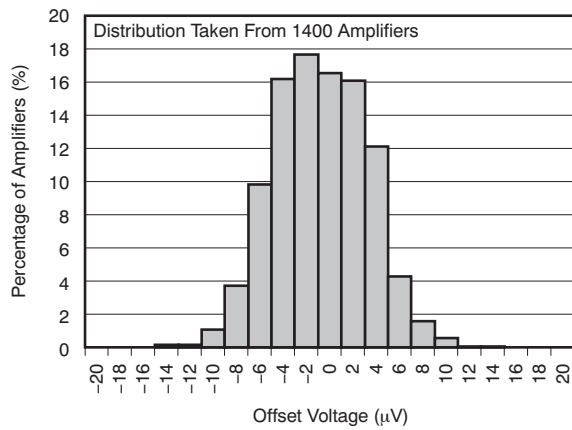

**Figure 1.**

**OFFSET VOLTAGE DRIFT DISTRIBUTION**

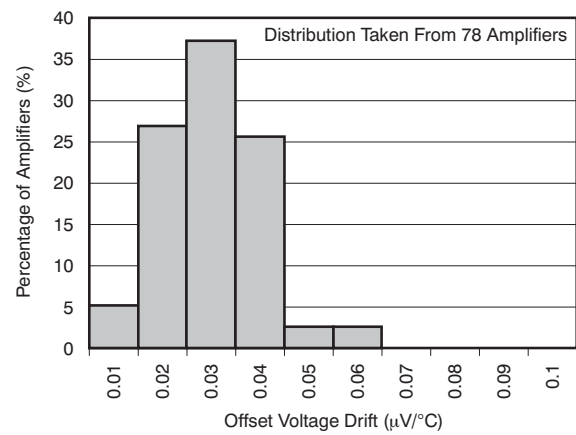

**Figure 2.**

**OFFSET VOLTAGE vs TEMPERATURE**

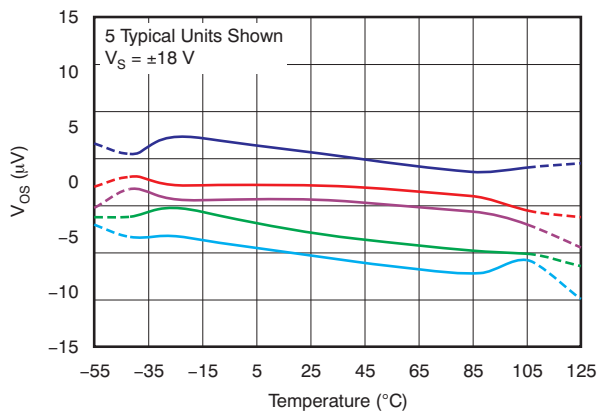

**Figure 3.**

**OFFSET VOLTAGE vs COMMON-MODE VOLTAGE**

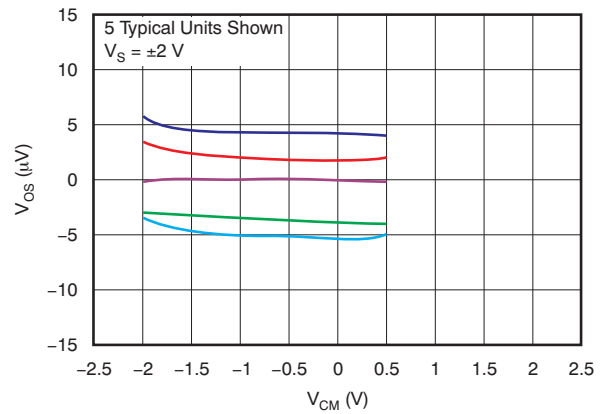

**Figure 4.**

**OFFSET VOLTAGE vs COMMON-MODE VOLTAGE**

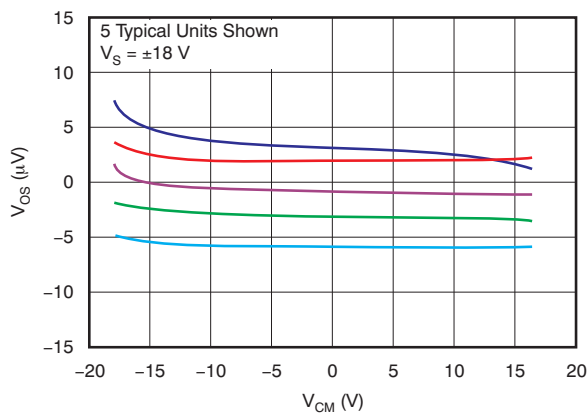

**Figure 5.**

**OFFSET VOLTAGE vs POWER SUPPLY**

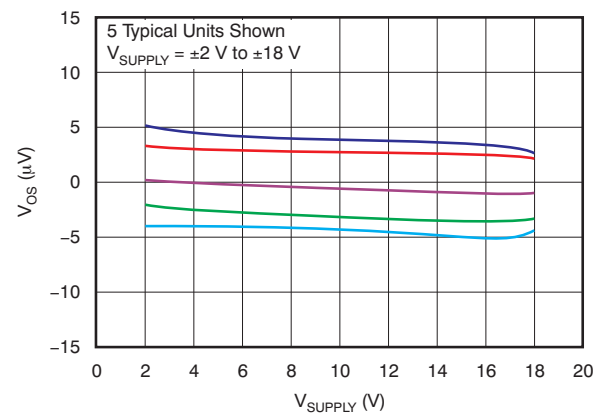

**Figure 6.**

**TYPICAL CHARACTERISTICS (continued)**

$V_S = \pm 18\text{ V}$ ,  $V_{CM} = V_S/2$ ,  $R_{LOAD} = 10\text{ k}\Omega$  connected to  $V_S/2$ , and  $C_L = 100\text{ pF}$ , unless otherwise noted.

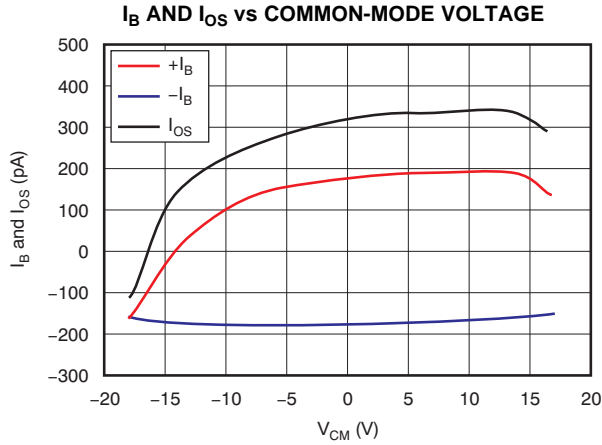

Figure 7.

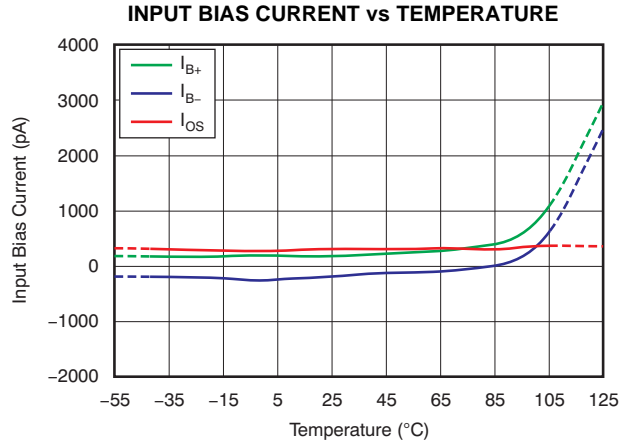

Figure 8.

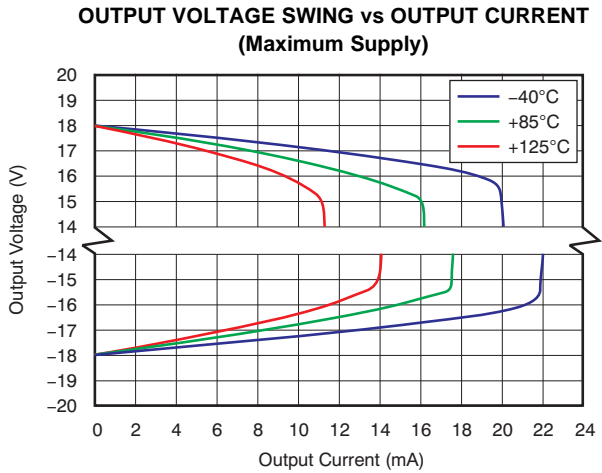

Figure 9.

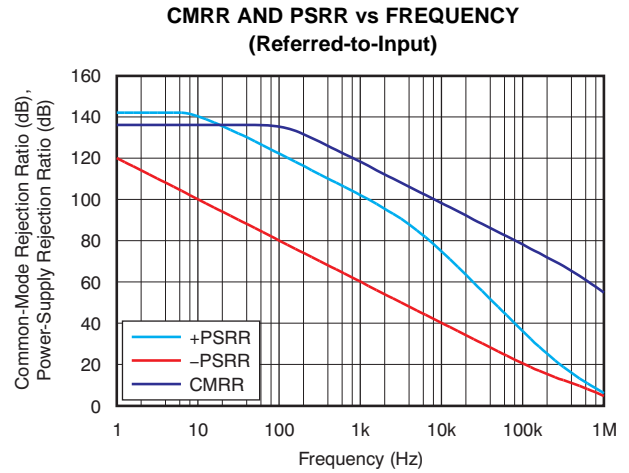

Figure 10.

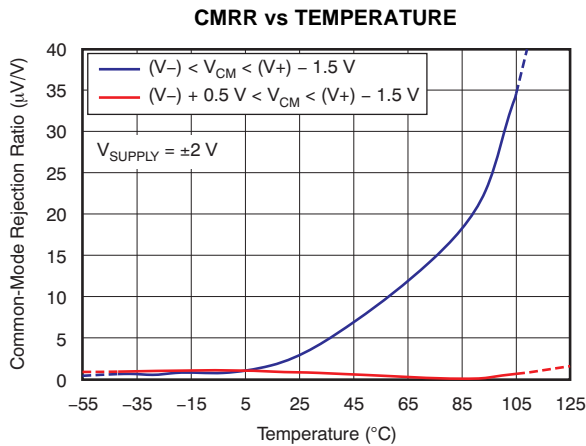

Figure 11.

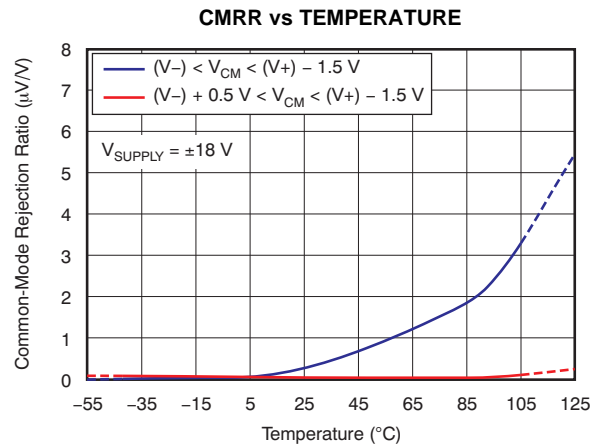
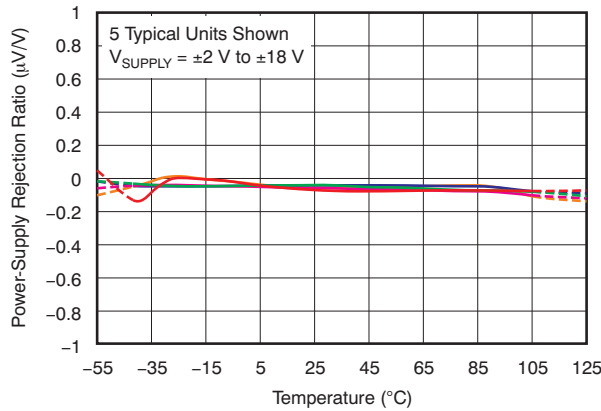

Figure 12.

**TYPICAL CHARACTERISTICS (continued)**

$V_S = \pm 18\text{ V}$ ,  $V_{CM} = V_S/2$ ,  $R_{LOAD} = 10\text{ k}\Omega$  connected to  $V_S/2$ , and  $C_L = 100\text{ pF}$ , unless otherwise noted.

**PSRR vs TEMPERATURE**



**Figure 13.**

**0.1-Hz TO 10-Hz NOISE**

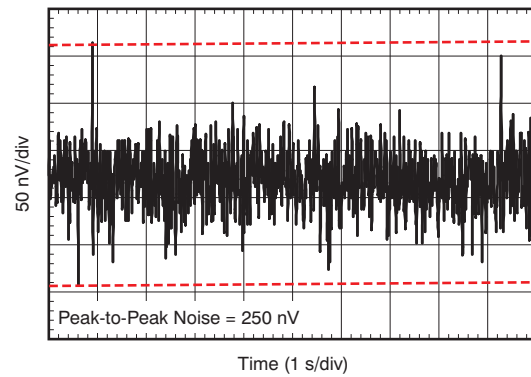

**Figure 14.**

**INPUT VOLTAGE NOISE SPECTRAL DENSITY vs FREQUENCY**

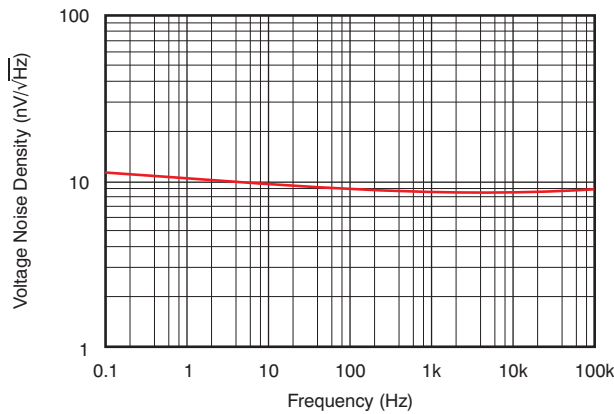

**Figure 15.**

**THD+N RATIO vs FREQUENCY**

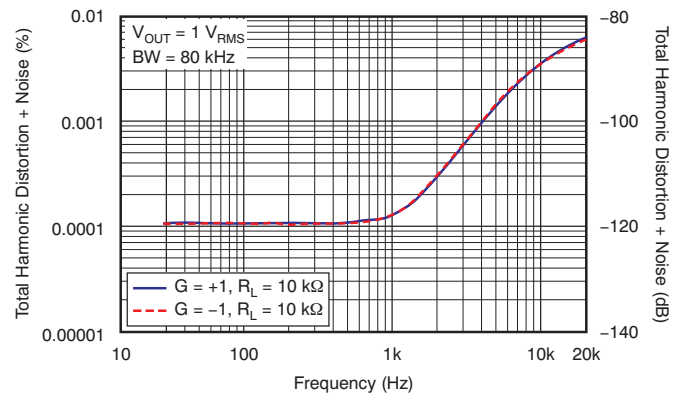

**Figure 16.**

**THD+N vs OUTPUT AMPLITUDE**

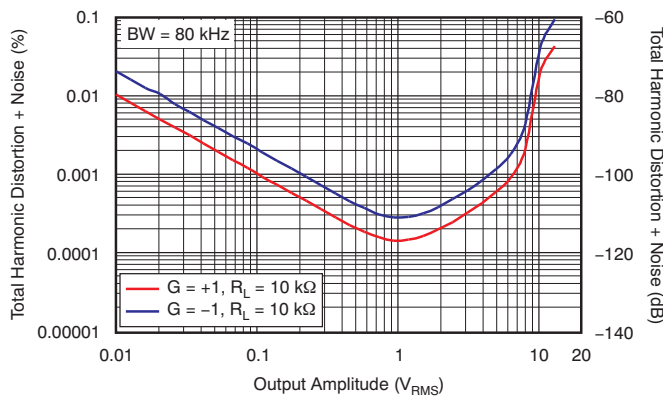

**Figure 17.**

**QUIESCENT CURRENT vs SUPPLY VOLTAGE**

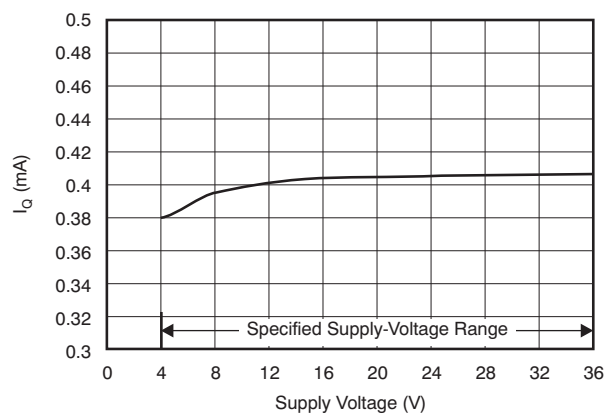

**Figure 18.**

**TYPICAL CHARACTERISTICS (continued)**

$V_S = \pm 18\text{ V}$ ,  $V_{CM} = V_S/2$ ,  $R_{LOAD} = 10\text{ k}\Omega$  connected to  $V_S/2$ , and  $C_L = 100\text{ pF}$ , unless otherwise noted.

**QUIESCENT CURRENT vs TEMPERATURE**

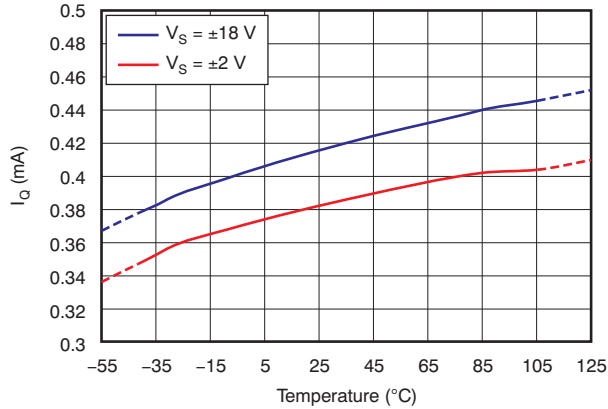

Figure 19.

**OPEN-LOOP GAIN AND PHASE vs FREQUENCY**

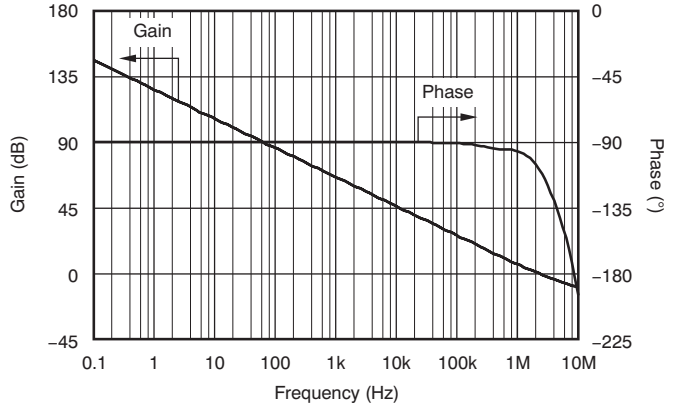

Figure 20.

**CLOSED-LOOP GAIN vs FREQUENCY**

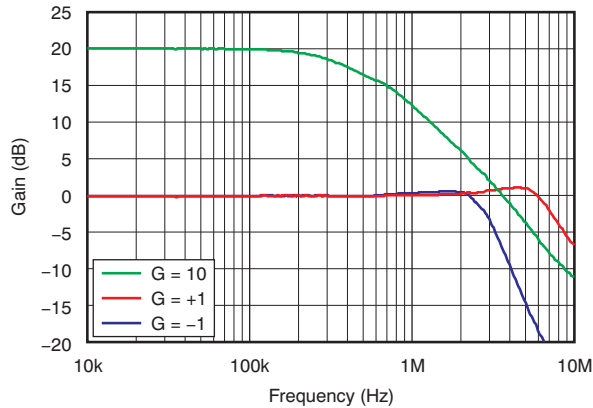

Figure 21.

**OPEN-LOOP GAIN vs TEMPERATURE**

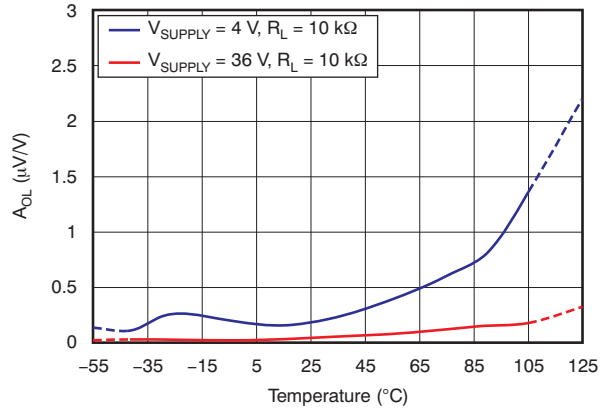

Figure 22.

**OPEN-LOOP OUTPUT IMPEDANCE vs FREQUENCY**

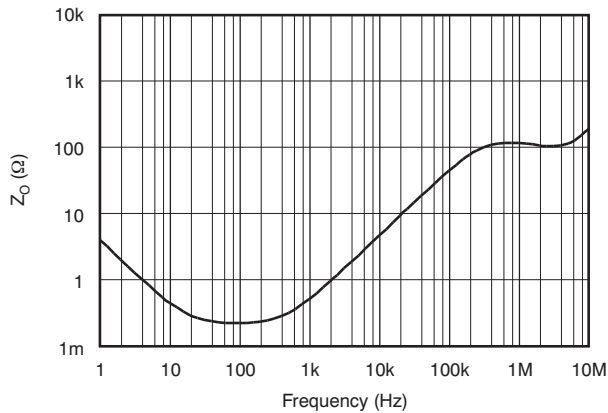

Figure 23.

**SMALL-SIGNAL OVERSHOOT vs CAPACITIVE LOAD (100-mV Output Step)**

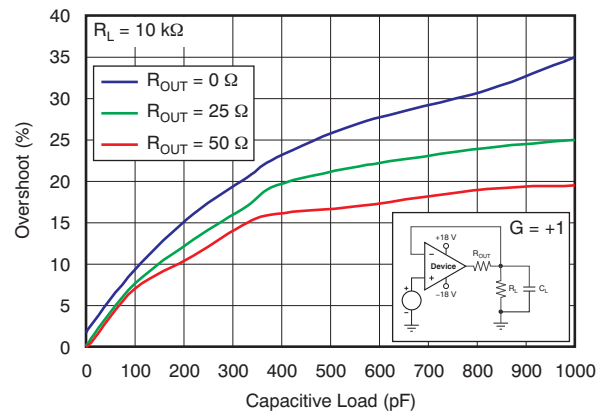

Figure 24.

**TYPICAL CHARACTERISTICS (continued)**

$V_S = \pm 18\text{ V}$ ,  $V_{CM} = V_S/2$ ,  $R_{LOAD} = 10\text{ k}\Omega$  connected to  $V_S/2$ , and  $C_L = 100\text{ pF}$ , unless otherwise noted.

**SMALL-SIGNAL OVERSHOOT vs CAPACITIVE LOAD  
(100-mV Output Step)**

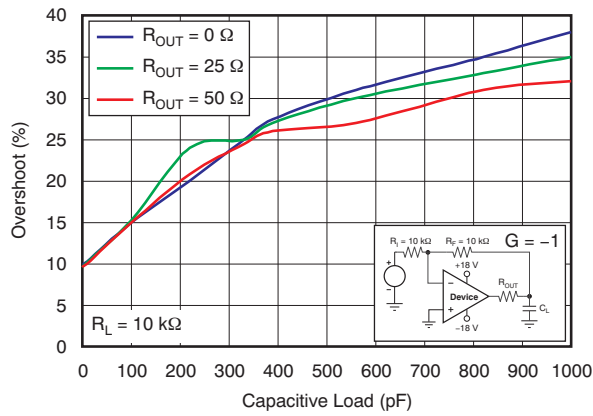

Figure 25.

**NO PHASE REVERSAL**

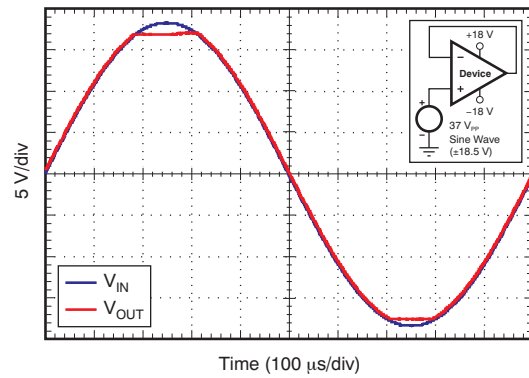

Figure 26.

**POSITIVE OVERLOAD RECOVERY**

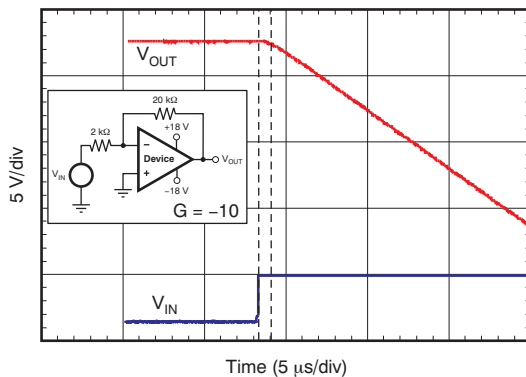

Figure 27.

**NEGATIVE OVERLOAD RECOVERY**

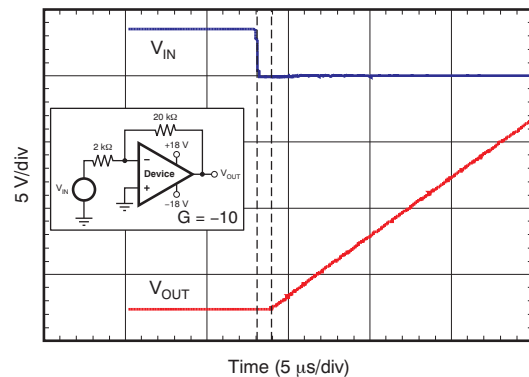

Figure 28.

**SMALL-SIGNAL STEP RESPONSE  
(100 mV)**

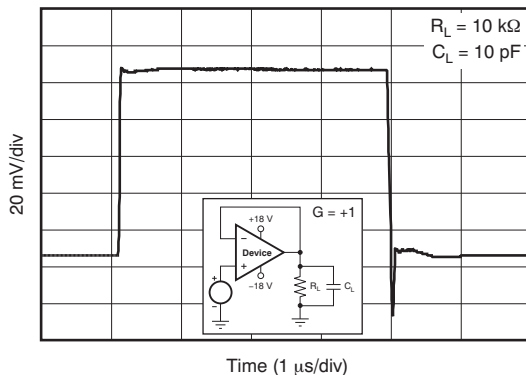

Figure 29.

**SMALL-SIGNAL STEP RESPONSE  
(100 mV)**

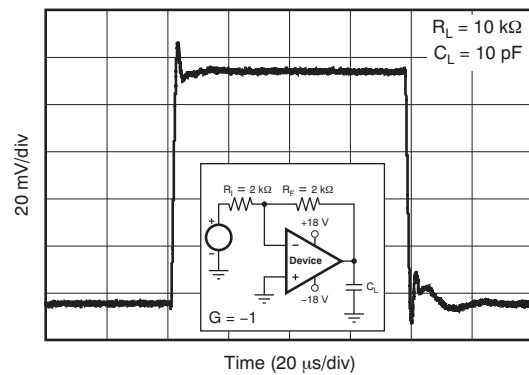
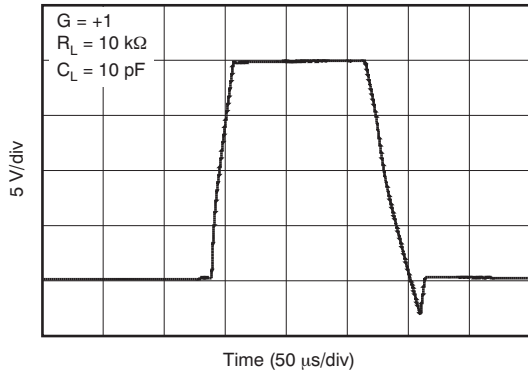

Figure 30.

**TYPICAL CHARACTERISTICS (continued)**

$V_S = \pm 18\text{ V}$ ,  $V_{CM} = V_S/2$ ,  $R_{LOAD} = 10\text{ k}\Omega$  connected to  $V_S/2$ , and  $C_L = 100\text{ pF}$ , unless otherwise noted.

**LARGE-SIGNAL STEP RESPONSE**



**Figure 31.**

**LARGE-SIGNAL STEP RESPONSE**

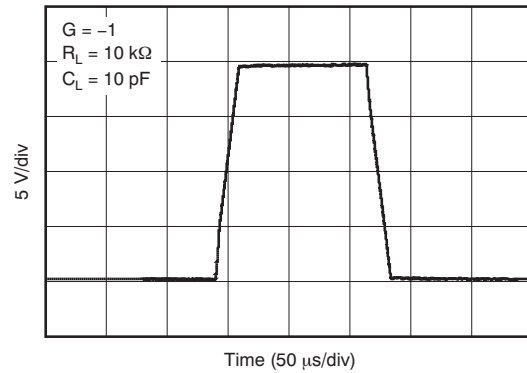

**Figure 32.**

**LARGE-SIGNAL SETTLING TIME  
 (10-V Positive Step)**

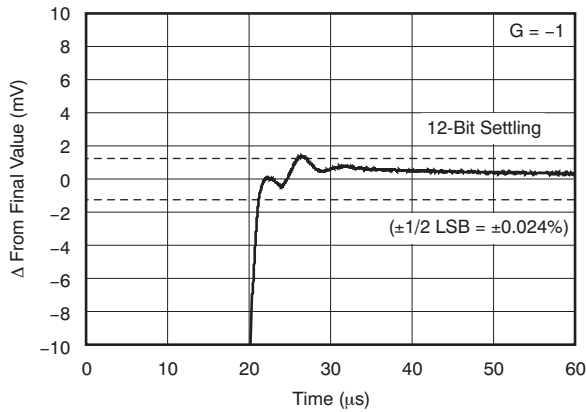

**Figure 33.**

**LARGE-SIGNAL SETTLING TIME  
 (10-V Negative Step)**

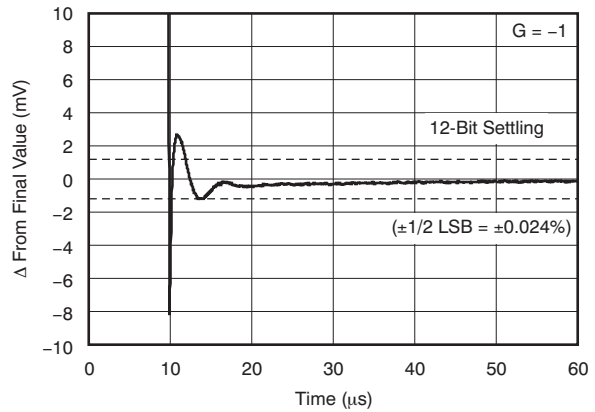

**Figure 34.**

**SHORT-CIRCUIT CURRENT vs TEMPERATURE**

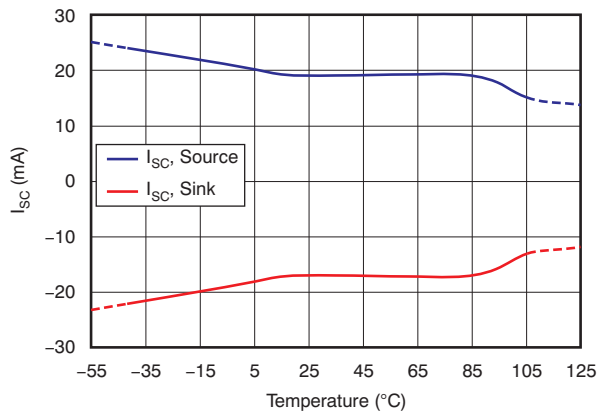

**Figure 35.**

**MAXIMUM OUTPUT VOLTAGE vs FREQUENCY**

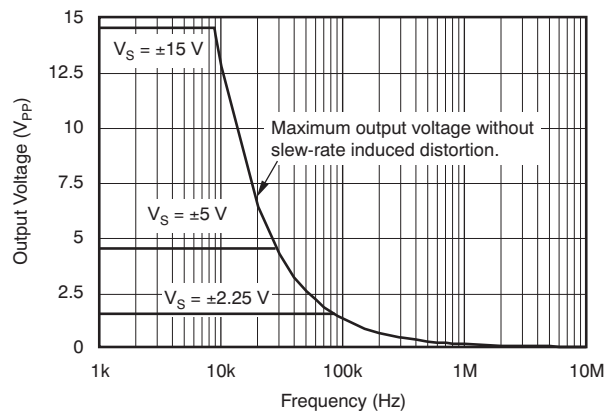

**Figure 36.**

**TYPICAL CHARACTERISTICS (continued)**

$V_S = \pm 18\text{ V}$ ,  $V_{CM} = V_S/2$ ,  $R_{LOAD} = 10\text{ k}\Omega$  connected to  $V_S/2$ , and  $C_L = 100\text{ pF}$ , unless otherwise noted.

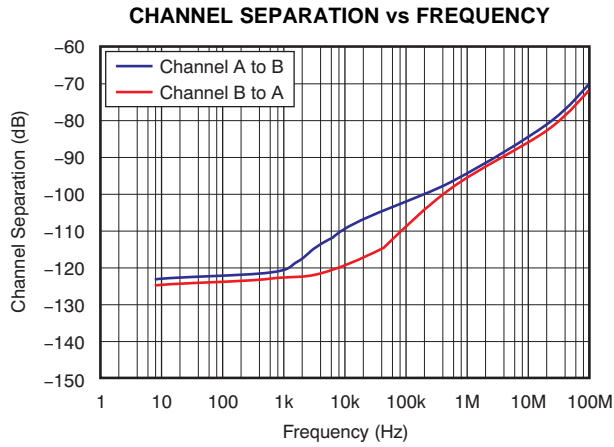

**Figure 37.**

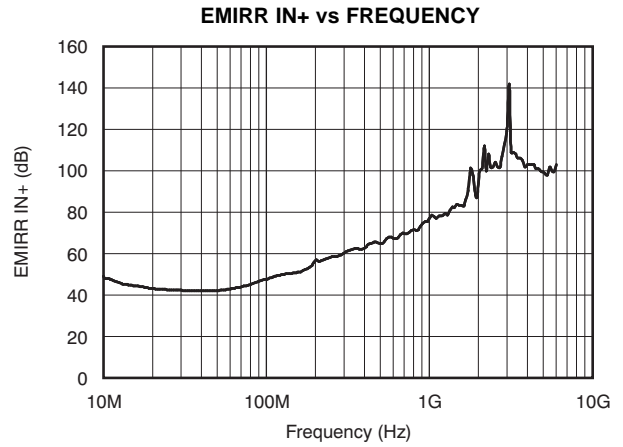

**Figure 38.**

## APPLICATION INFORMATION

The OPAx188 family of operational amplifiers combine precision offset and drift with excellent overall performance, making them ideal for many precision applications. The precision offset drift of only 0.085  $\mu\text{V}/^\circ\text{C}$  provides stability over the entire temperature range. In addition, the device offers excellent overall performance with high CMRR, PSRR, and  $A_{OL}$ . As with all amplifiers, applications with noisy or high-impedance power supplies require decoupling capacitors close to the device pins. In most cases, 0.1- $\mu\text{F}$  capacitors are adequate.

### OPERATING CHARACTERISTICS

The OPAx188 family of amplifiers is specified for operation from 4 V to 36 V ( $\pm 2$  V to  $\pm 18$  V). Many of the specifications apply from  $-40^\circ\text{C}$  to  $+105^\circ\text{C}$ . Parameters that can exhibit significant variance with regard to operating voltage or temperature are presented in the [Typical Characteristics](#).

### EMI REJECTION

The OPAx188 uses integrated electromagnetic interference (EMI) filtering to reduce the effects of EMI interference from sources such as wireless communications and densely populated boards with a mix of analog signal chain and digital components. EMI immunity can be improved with circuit design techniques; the OPAx188 benefits from these design improvements. Texas Instruments has developed the ability to accurately measure and quantify the immunity of an operational amplifier over a broad frequency spectrum extending from 10 MHz to 6 GHz. [Figure 39](#) shows the results of this testing on the OPAx188. Detailed information can also be found in the [Application Report EMI Rejection Ratio of Operational Amplifiers \(SBOA128\)](#), available for download from the TI website.

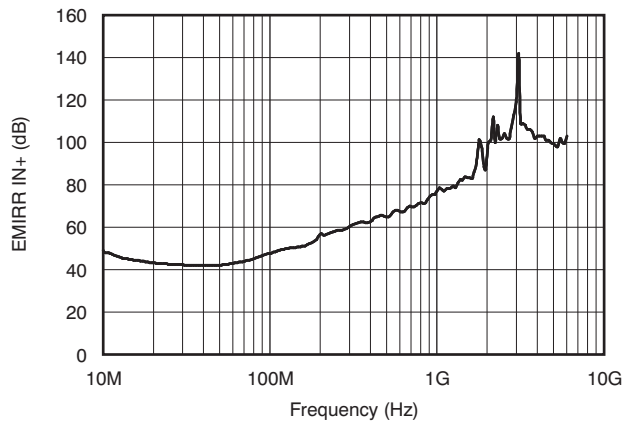

**Figure 39. OPAx188 EMIRR Testing**



## GENERAL LAYOUT GUIDELINES

For best operational performance of the device, good printed circuit board (PCB) layout practices are recommended. Low-loss, 0.1- $\mu\text{F}$  bypass capacitors should be connected between each supply pin and ground, placed as close to the device as possible. A single bypass capacitor from V+ to ground is applicable to single-supply applications.

## PHASE-REVERSAL PROTECTION

The OPAx188 family has an internal phase-reversal protection. Many op amps exhibit a phase reversal when the input is driven beyond its linear common-mode range. This condition is most often encountered in noninverting circuits when the input is driven beyond the specified common-mode voltage range, causing the output to reverse into the opposite rail. The input of the OPAx188 prevents phase reversal with excessive common-mode voltage. Instead, the output limits into the appropriate rail. This performance is shown in Figure 40.

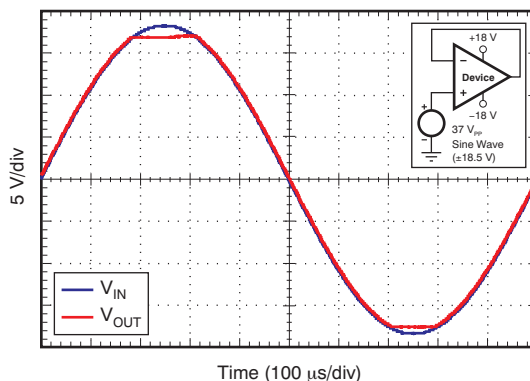

Figure 40. No Phase Reversal

## CAPACITIVE LOAD AND STABILITY

The dynamic characteristics of the OPAx188 have been optimized for a range of common operating conditions. The combination of low closed-loop gain and high capacitive loads decreases the phase margin of the amplifier and can lead to gain peaking or oscillations. As a result, heavier capacitive loads must be isolated from the output. The simplest way to achieve this isolation is to add a small resistor (for example,  $R_{OUT}$  equal to 50  $\Omega$ ) in series with the output. Figure 41 and Figure 42 illustrate graphs of small-signal overshoot versus capacitive load for several values of  $R_{OUT}$ . Also, refer to the [Applications Report, Feedback Plots Define Op Amp AC Performance \(SBOA015\)](#), available for download from the TI website, for details of analysis techniques and application circuits.

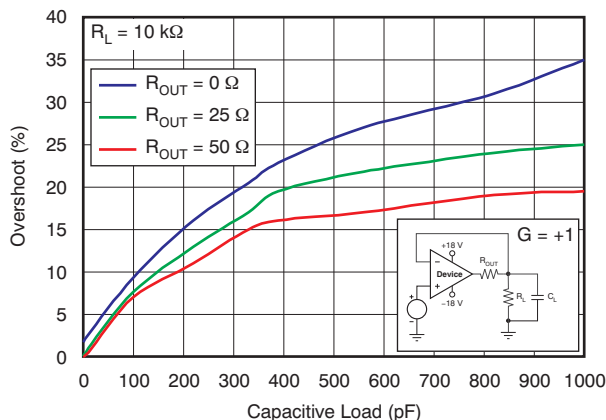

Figure 41. Small-Signal Overshoot versus Capacitive Load (100-mV Output Step)

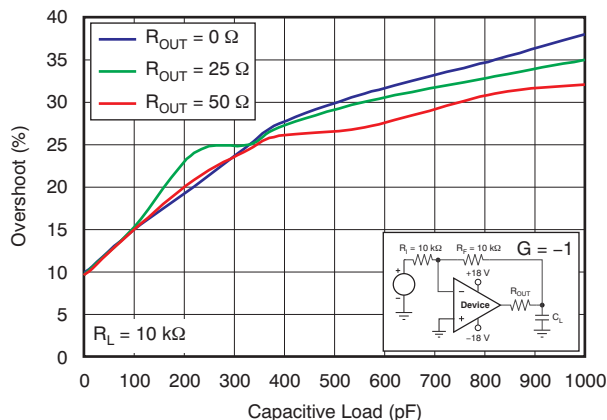
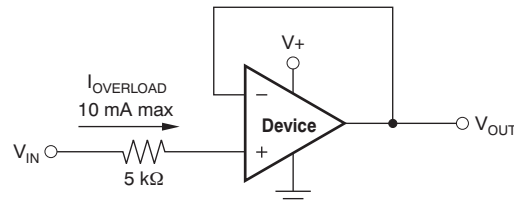

Figure 42. Small-Signal Overshoot versus Capacitive Load (100-mV Output Step)

## ELECTRICAL OVERSTRESS

Designers often ask questions about the capability of an operational amplifier to withstand electrical overstress. These questions tend to focus on the device inputs, but may involve the supply voltage pins or even the output pin. Each of these different pin functions have electrical stress limits determined by the voltage breakdown characteristics of the particular semiconductor fabrication process and specific circuits connected to the pin. Additionally, internal electrostatic discharge (ESD) protection is built into these circuits to protect them from accidental ESD events both before and during product assembly.

These ESD protection diodes also provide in-circuit, input overdrive protection, as long as the current is limited to 10 mA as stated in the [Absolute Maximum Ratings](#). [Figure 43](#) shows how a series input resistor may be added to the driven input to limit the input current. The added resistor contributes thermal noise at the amplifier input and its value should be kept to a minimum in noise-sensitive applications.



**Figure 43. Input Current Protection**

An ESD event produces a short duration, high-voltage pulse that is transformed into a short duration, high-current pulse as it discharges through a semiconductor device. The ESD protection circuits are designed to provide a current path around the operational amplifier core to prevent it from being damaged. The energy absorbed by the protection circuitry is then dissipated as heat.

When the operational amplifier connects into a circuit, the ESD protection components are intended to remain inactive and not become involved in the application circuit operation. However, circumstances may arise where an applied voltage exceeds the operating voltage range of a given pin. Should this condition occur, there is a risk that some of the internal ESD protection circuits may be biased on, and conduct current. Any such current flow occurs through ESD cells and rarely involves the absorption device.

If there is an uncertainty about the ability of the supply to absorb this current, external zener diodes may be added to the supply pins. The zener voltage must be selected such that the diode does not turn on during normal operation.

However, its zener voltage should be low enough so that the zener diode conducts if the supply pin begins to rise above the safe operating supply voltage level.

## APPLICATION EXAMPLES

The application examples of [Figure 44](#) and [Figure 45](#) highlight only a few of the circuits where the OPAx188 family of devices can be used.

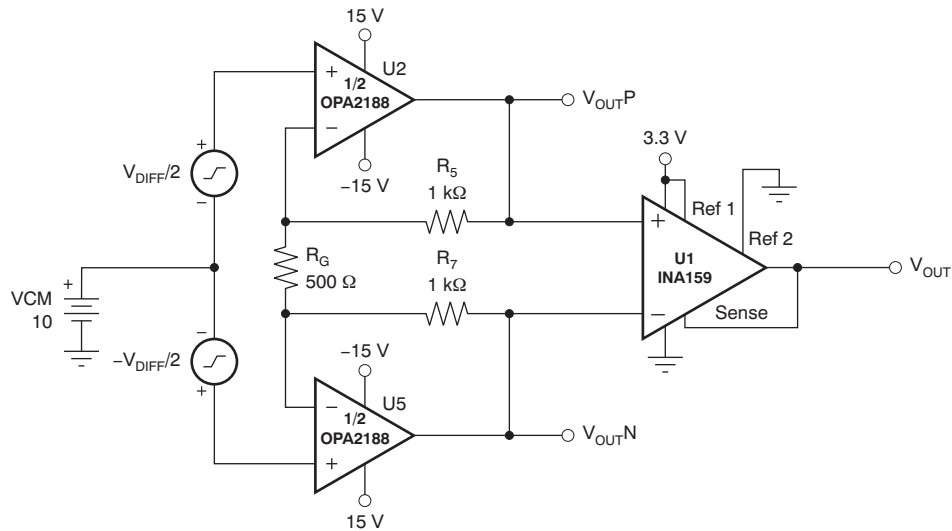
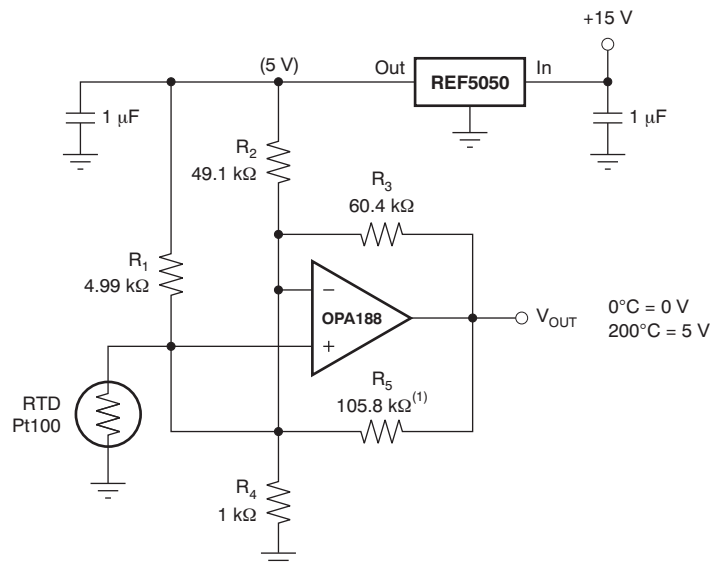

Figure 44. Discrete INA + Attenuation for ADC with 3.3-V Supply



(1)  $R_5$  provides positive-varying excitation to linearize output.

Figure 45. RTD Amplifier with Linearization

**PACKAGING INFORMATION**

Orderable Device	Status <sup>(1)</sup>	Package Type	Package Drawing	Pins	Package Qty	Eco Plan <sup>(2)</sup>	Lead/ Ball Finish	MSL Peak Temp <sup>(3)</sup>	Samples (Requires Login)
OPA2188AID	PREVIEW	SOIC	D	8		TBD	Call TI	Call TI	
OPA2188AIDGKR	ACTIVE	MSOP	DGK	8	2500	Green (RoHS & no Sb/Br)	CU NIPDAU	Level-2-260C-1 YEAR	
OPA2188AIDGKT	ACTIVE	MSOP	DGK	8	250	Green (RoHS & no Sb/Br)	CU NIPDAU	Level-2-260C-1 YEAR	
OPA2188AIDR	PREVIEW	SOIC	D	8		TBD	Call TI	Call TI	

<sup>(1)</sup> The marketing status values are defined as follows:

**ACTIVE:** Product device recommended for new designs.

**LIFEBUY:** TI has announced that the device will be discontinued, and a lifetime-buy period is in effect.

**NRND:** Not recommended for new designs. Device is in production to support existing customers, but TI does not recommend using this part in a new design.

**PREVIEW:** Device has been announced but is not in production. Samples may or may not be available.

**OBSELETE:** TI has discontinued the production of the device.

<sup>(2)</sup> Eco Plan - The planned eco-friendly classification: Pb-Free (RoHS), Pb-Free (RoHS Exempt), or Green (RoHS & no Sb/Br) - please check <http://www.ti.com/productcontent> for the latest availability information and additional product content details.

**TBD:** The Pb-Free/Green conversion plan has not been defined.

**Pb-Free (RoHS):** TI's terms "Lead-Free" or "Pb-Free" mean semiconductor products that are compatible with the current RoHS requirements for all 6 substances, including the requirement that lead not exceed 0.1% by weight in homogeneous materials. Where designed to be soldered at high temperatures, TI Pb-Free products are suitable for use in specified lead-free processes.

**Pb-Free (RoHS Exempt):** This component has a RoHS exemption for either 1) lead-based flip-chip solder bumps used between the die and package, or 2) lead-based die adhesive used between the die and leadframe. The component is otherwise considered Pb-Free (RoHS compatible) as defined above.

**Green (RoHS & no Sb/Br):** TI defines "Green" to mean Pb-Free (RoHS compatible), and free of Bromine (Br) and Antimony (Sb) based flame retardants (Br or Sb do not exceed 0.1% by weight in homogeneous material)

<sup>(3)</sup> MSL, Peak Temp. -- The Moisture Sensitivity Level rating according to the JEDEC industry standard classifications, and peak solder temperature.

**Important Information and Disclaimer:** The information provided on this page represents TI's knowledge and belief as of the date that it is provided. TI bases its knowledge and belief on information provided by third parties, and makes no representation or warranty as to the accuracy of such information. Efforts are underway to better integrate information from third parties. TI has taken and continues to take reasonable steps to provide representative and accurate information but may not have conducted destructive testing or chemical analysis on incoming materials and chemicals. TI and TI suppliers consider certain information to be proprietary, and thus CAS numbers and other limited information may not be available for release.

In no event shall TI's liability arising out of such information exceed the total purchase price of the TI part(s) at issue in this document sold by TI to Customer on an annual basis.

DGK (S-PDSO-G8)

PLASTIC SMALL-OUTLINE PACKAGE

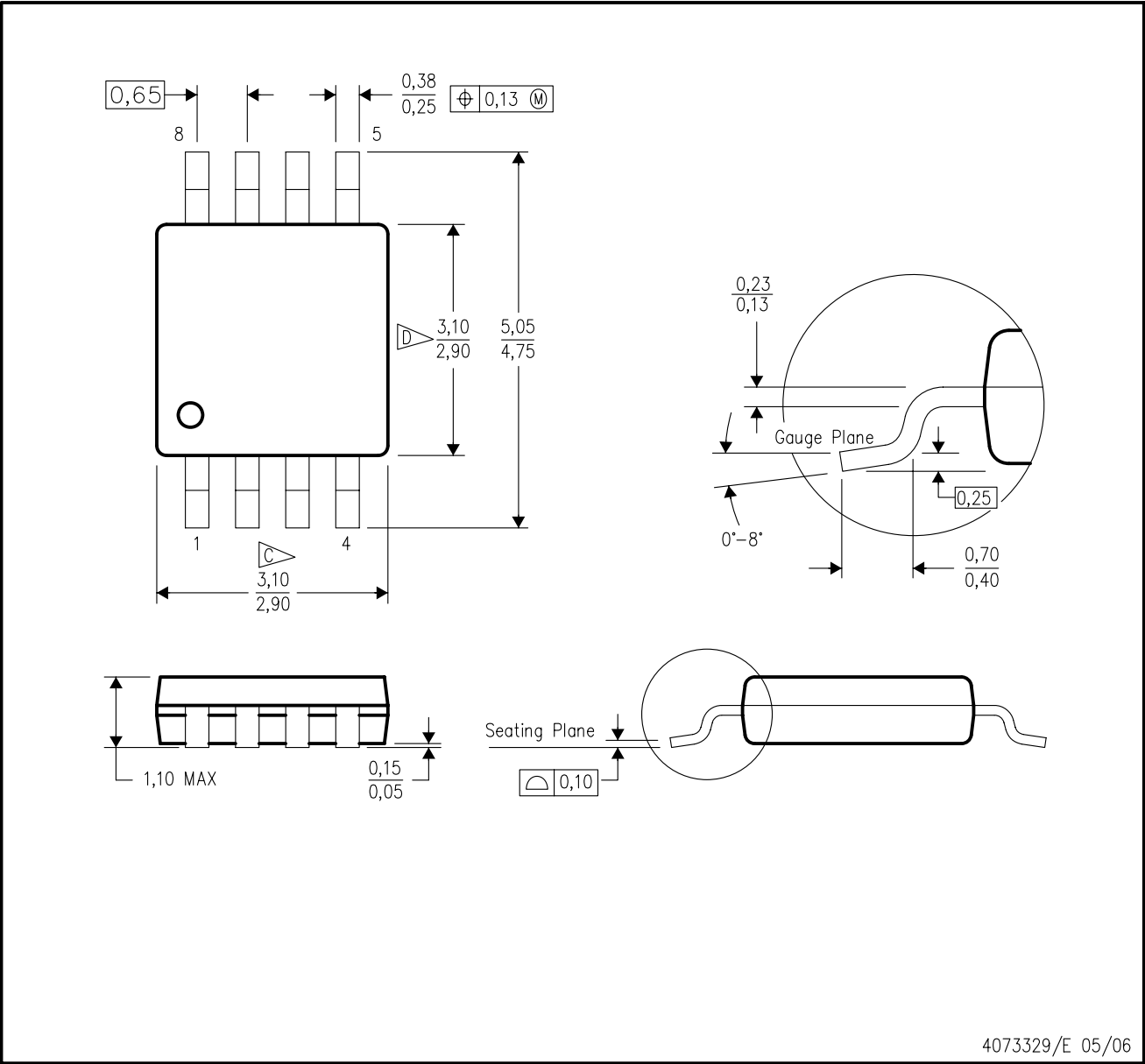

- NOTES:
- A. All linear dimensions are in millimeters.
  - B. This drawing is subject to change without notice.
  - C. Body length does not include mold flash, protrusions, or gate burrs. Mold flash, protrusions, or gate burrs shall not exceed 0.15 per end.
  - D. Body width does not include interlead flash. Interlead flash shall not exceed 0.50 per side.
  - E. Falls within JEDEC MO-187 variation AA, except interlead flash.

D (R-PDSO-G8)

PLASTIC SMALL OUTLINE

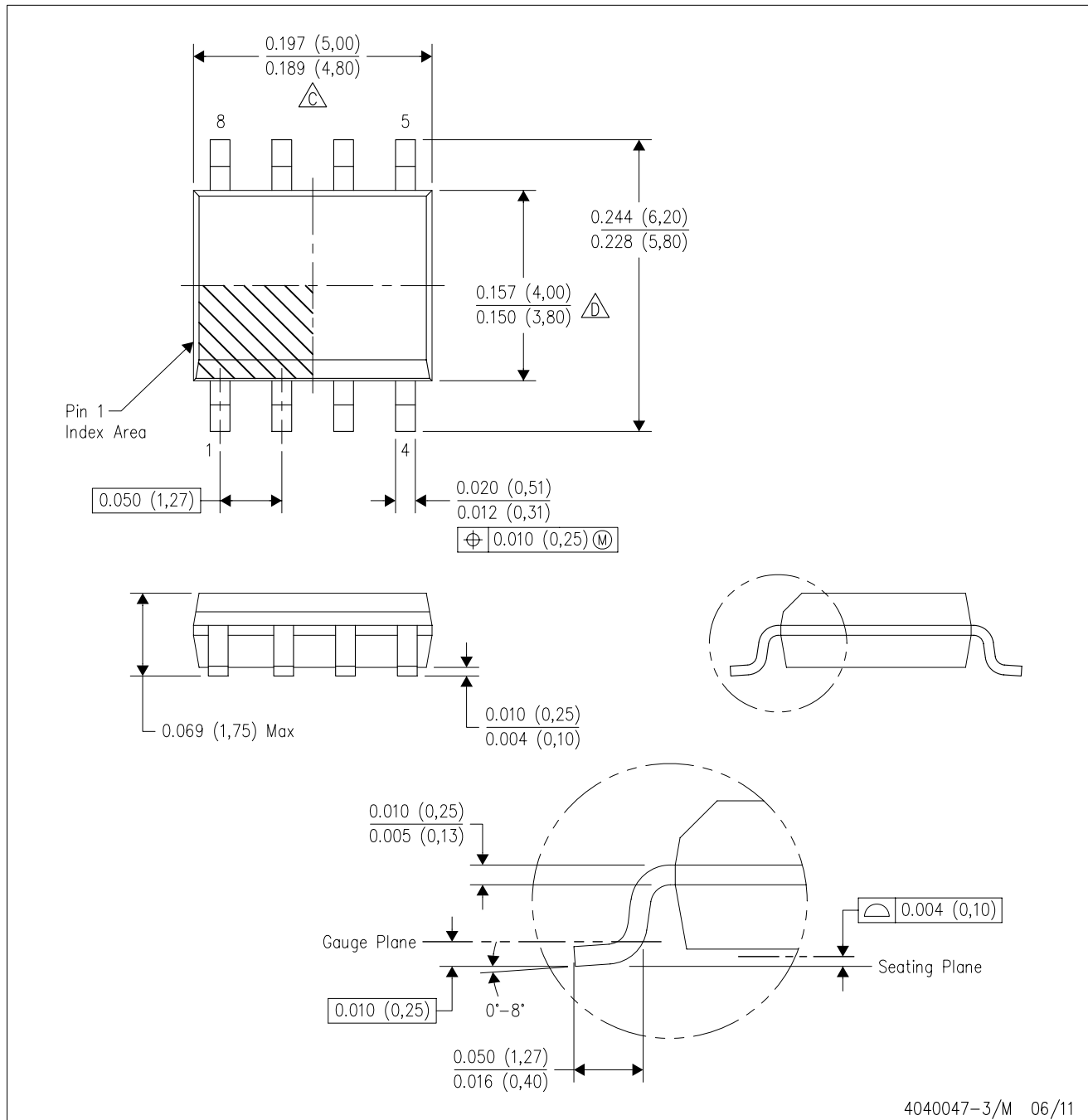

- NOTES:
- A. All linear dimensions are in inches (millimeters).
  - B. This drawing is subject to change without notice.
  - Body length does not include mold flash, protrusions, or gate burrs. Mold flash, protrusions, or gate burrs shall not exceed 0.006 (0,15) each side.
  - Body width does not include interlead flash. Interlead flash shall not exceed 0.017 (0,43) each side.
  - E. Reference JEDEC MS-012 variation AA.

## IMPORTANT NOTICE

Texas Instruments Incorporated and its subsidiaries (TI) reserve the right to make corrections, modifications, enhancements, improvements, and other changes to its products and services at any time and to discontinue any product or service without notice. Customers should obtain the latest relevant information before placing orders and should verify that such information is current and complete. All products are sold subject to TI's terms and conditions of sale supplied at the time of order acknowledgment.

TI warrants performance of its hardware products to the specifications applicable at the time of sale in accordance with TI's standard warranty. Testing and other quality control techniques are used to the extent TI deems necessary to support this warranty. Except where mandated by government requirements, testing of all parameters of each product is not necessarily performed.

TI assumes no liability for applications assistance or customer product design. Customers are responsible for their products and applications using TI components. To minimize the risks associated with customer products and applications, customers should provide adequate design and operating safeguards.

TI does not warrant or represent that any license, either express or implied, is granted under any TI patent right, copyright, mask work right, or other TI intellectual property right relating to any combination, machine, or process in which TI products or services are used. Information published by TI regarding third-party products or services does not constitute a license from TI to use such products or services or a warranty or endorsement thereof. Use of such information may require a license from a third party under the patents or other intellectual property of the third party, or a license from TI under the patents or other intellectual property of TI.

Reproduction of TI information in TI data books or data sheets is permissible only if reproduction is without alteration and is accompanied by all associated warranties, conditions, limitations, and notices. Reproduction of this information with alteration is an unfair and deceptive business practice. TI is not responsible or liable for such altered documentation. Information of third parties may be subject to additional restrictions.

Resale of TI products or services with statements different from or beyond the parameters stated by TI for that product or service voids all express and any implied warranties for the associated TI product or service and is an unfair and deceptive business practice. TI is not responsible or liable for any such statements.

TI products are not authorized for use in safety-critical applications (such as life support) where a failure of the TI product would reasonably be expected to cause severe personal injury or death, unless officers of the parties have executed an agreement specifically governing such use. Buyers represent that they have all necessary expertise in the safety and regulatory ramifications of their applications, and acknowledge and agree that they are solely responsible for all legal, regulatory and safety-related requirements concerning their products and any use of TI products in such safety-critical applications, notwithstanding any applications-related information or support that may be provided by TI. Further, Buyers must fully indemnify TI and its representatives against any damages arising out of the use of TI products in such safety-critical applications.

TI products are neither designed nor intended for use in military/aerospace applications or environments unless the TI products are specifically designated by TI as military-grade or "enhanced plastic." Only products designated by TI as military-grade meet military specifications. Buyers acknowledge and agree that any such use of TI products which TI has not designated as military-grade is solely at the Buyer's risk, and that they are solely responsible for compliance with all legal and regulatory requirements in connection with such use.

TI products are neither designed nor intended for use in automotive applications or environments unless the specific TI products are designated by TI as compliant with ISO/TS 16949 requirements. Buyers acknowledge and agree that, if they use any non-designated products in automotive applications, TI will not be responsible for any failure to meet such requirements.

Following are URLs where you can obtain information on other Texas Instruments products and application solutions:

### Products

Audio	<a href="http://www.ti.com/audio">www.ti.com/audio</a>
Amplifiers	<a href="http://amplifier.ti.com">amplifier.ti.com</a>
Data Converters	<a href="http://dataconverter.ti.com">dataconverter.ti.com</a>
DLP® Products	<a href="http://www.dlp.com">www.dlp.com</a>
DSP	<a href="http://dsp.ti.com">dsp.ti.com</a>
Clocks and Timers	<a href="http://www.ti.com/clocks">www.ti.com/clocks</a>
Interface	<a href="http://interface.ti.com">interface.ti.com</a>
Logic	<a href="http://logic.ti.com">logic.ti.com</a>
Power Mgmt	<a href="http://power.ti.com">power.ti.com</a>
Microcontrollers	<a href="http://microcontroller.ti.com">microcontroller.ti.com</a>
RFID	<a href="http://www.ti-rfid.com">www.ti-rfid.com</a>
RF/IF and ZigBee® Solutions	<a href="http://www.ti.com/lprf">www.ti.com/lprf</a>

### Applications

Communications and Telecom	<a href="http://www.ti.com/communications">www.ti.com/communications</a>
Computers and Peripherals	<a href="http://www.ti.com/computers">www.ti.com/computers</a>
Consumer Electronics	<a href="http://www.ti.com/consumer-apps">www.ti.com/consumer-apps</a>
Energy and Lighting	<a href="http://www.ti.com/energy">www.ti.com/energy</a>
Industrial	<a href="http://www.ti.com/industrial">www.ti.com/industrial</a>
Medical	<a href="http://www.ti.com/medical">www.ti.com/medical</a>
Security	<a href="http://www.ti.com/security">www.ti.com/security</a>
Space, Avionics and Defense	<a href="http://www.ti.com/space-avionics-defense">www.ti.com/space-avionics-defense</a>
Transportation and Automotive	<a href="http://www.ti.com/automotive">www.ti.com/automotive</a>
Video and Imaging	<a href="http://www.ti.com/video">www.ti.com/video</a>
Wireless	<a href="http://www.ti.com/wireless-apps">www.ti.com/wireless-apps</a>

TI E2E Community Home Page

[e2e.ti.com](http://e2e.ti.com)

Mailing Address: Texas Instruments, Post Office Box 655303, Dallas, Texas 75265  
Copyright © 2011, Texas Instruments Incorporated