

CD4555B, CD4556B Types

CMOS Dual Binary to 1 of 4 Decoder/Demultiplexers

High-Voltage Types (20-Volt Rating)

CD4555B: Outputs High on Select

CD4556B: Outputs Low on Select

■ CD4555B and CD4556B are dual one-of-four decoders/demultiplexers. Each decoder has two select inputs (A and B), an Enable input (\bar{E}), and four mutually exclusive outputs. On the CD4555B the outputs are high on select; on the CD4556B the outputs are low on select.

When the Enable input is high, the outputs of the CD4555B remain low and the outputs of the CD4556B remain high regardless of the state of the select inputs A and B. The CD4555B and CD4556B are similar to types MC14555 and MC14556, respectively.

The CD4555B and CD4556B types are supplied in 16-lead hermetic dual-in-line ceramic packages (F3A suffix), 16-lead dual-in-line plastics packages (E suffix), and 16-lead small-outline packages (M, M96, and MT suffixes). The CD4555B is also supplied in 16-lead small-outline packages (NSR suffix) and 16-lead thin shrink small-outline packages (PW and PWR suffixes.)

RECOMMENDED OPERATING CONDITIONS

For maximum reliability, nominal operating conditions should be selected so that operation is always within the following ranges.

CHARACTERISTIC	V _{DD}	MIN.	MAX.	UNITS
Supply Voltage Range (For T _A = Full Package Temp. Range)	—	3	18	V

MAXIMUM RATINGS, Absolute-Maximum Values:

DC SUPPLY-VOLTAGE RANGE, (V_{DD})

Voltages referenced to V_{SS} Terminal) -0.5V to +20V

INPUT VOLTAGE RANGE, ALL INPUTS -0.5V to V_{DD} +0.5V

DC INPUT CURRENT, ANY ONE INPUT ±10mA

POWER DISSIPATION PER PACKAGE (P_D):

For T_A = -55°C to +100°C 500mW

For T_A = +100°C to +125°C Derate Linearly at 12mW/°C to 200mW

DEVICE DISSIPATION PER OUTPUT TRANSISTOR

FOR T_A = FULL PACKAGE-TEMPERATURE RANGE (All Package Types)..... 100mW

OPERATING-TEMPERATURE RANGE (T_A) -55°C to +125°C

STORAGE TEMPERATURE RANGE (T_{stg}) -65°C to +150°C

LEAD TEMPERATURE (DURING SOLDERING):

At distance 1/16 ± 1/32 inch (1.59 ± 0.79mm) from case for 10s max +265°C

Features:

- Expandable with multiple packages
- Standard, symmetrical output characteristics
- 100% tested for quiescent current at 20 V
- Maximum input current of 1 μA at 18 V over full package temperature range; 100 nA at 18 V and 25°C
- Noise margin (full package-temperature range): 1 V at V_{DD} = 5 V
2 V at V_{DD} = 10 V
2.5 V at V_{DD} = 15 V
- 5-V, 10-V, and 15-V parametric ratings
- Meets all requirements of JEDEC Tentative Standard No. 13B, "Standard Specifications for Description of 'B' Series CMOS Devices"

Applications:

- Decoding
- Code conversion
- Demultiplexing (using Enable input as a data input)
- Memory chip-enable selection
- Function selection

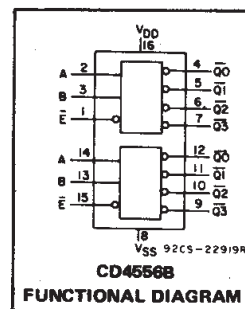
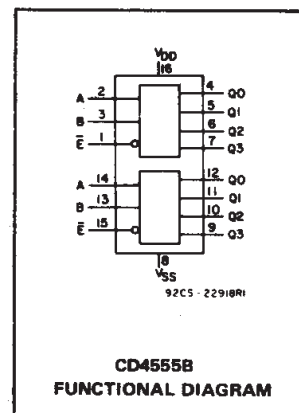

3
COMMERCIAL CMOS
HIGH VOLTAGE ICs

TERMINAL ASSIGNMENTS

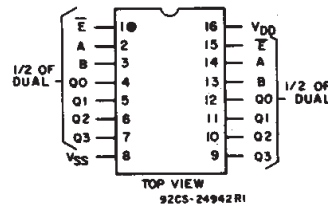
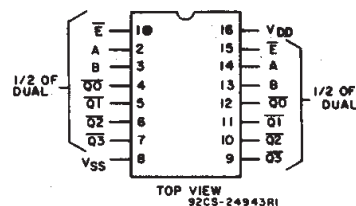

CD4555B, CD4556B Types

STATIC ELECTRICAL CHARACTERISTICS

CHARACTERISTIC	CONDITIONS			LIMITS AT INDICATED TEMPERATURES (°C)							UNITS
	V _O (V)	V _{IN} (V)	V _{DD} (V)	-55	-40	+85	+125	+25			
								Min.	Typ.	Max.	
Quiescent Device Current, I _{DD} Max.	—	0,5	5	5	5	150	150	—	0,04	5	μA
	—	0,10	10	10	10	300	300	—	0,04	10	
	—	0,15	15	20	20	600	600	—	0,04	20	
	—	0,20	20	100	100	3000	3000	—	0,08	100	
Output Low (Sink) Current I _{OL} Min.	0,4	0,5	5	0,64	0,61	0,42	0,36	0,51	1	—	mA
	0,5	0,10	10	1,6	1,5	1,1	0,9	1,3	2,6	—	
	1,5	0,15	15	4,2	4	2,8	2,4	3,4	6,8	—	
	—	—	—	—	—	—	—	—	—	—	
Output High (Source) Current, I _{OH} Min.	4,6	0,5	5	-0,64	-0,61	-0,42	-0,36	-0,51	-1	—	mA
	2,5	0,5	5	-2	-1,8	-1,3	-1,15	-1,6	-3,2	—	
	9,5	0,10	10	-1,6	-1,5	-1,1	-0,9	-1,3	-2,6	—	
	13,5	0,15	15	-4,2	-4	-2,8	-2,4	-3,4	-6,8	—	
Output Voltage: Low-Level, V _{OL} Max.	—	0,5	5	0,05			—	0	0,05	—	V
	—	0,10	10	0,05			—	0	0,05	—	
	—	0,15	15	0,05			—	0	0,05	—	
Output Voltage: High-Level, V _{OH} Min.	—	0,5	5	4,95			4,95	5	—	—	V
	—	0,10	10	9,95			9,95	10	—	—	
	—	0,15	15	14,95			14,95	15	—	—	
Input Low Voltage, V _{IL} Max.	0,5,4,5	—	5	1,5			—	—	1,5	—	V
	1,9	—	10	3			—	—	3	—	
	1,5,13,5	—	15	4			—	—	4	—	
Input High Voltage, V _{IH} Min.	0,5,4,5	—	5	3,5			3,5	—	—	—	V
	1,9	—	10	7			7	—	—	—	
	1,5,13,5	—	15	11			11	—	—	—	
Input Current I _{IN} Max.	—	0,18	18	±0,1	±0,1	±1	±1	—	±10 ⁻⁵	±0,1	μA

DYNAMIC ELECTRICAL CHARACTERISTICS at T_A = 25°C; Input t_p, t_f = 20 ns, C_L = 50 pF, R_L = 200 KΩ

CHARACTERISTIC	TEST CONDITIONS	LIMITS		UNITS	
		V _{DD} Volts	TYP.		MAX.
Propagation Delay Time, t _{PHL} , A or B Input to t _{PLH} Any Output		5	220	440	ns
		10	95	190	
		15	70	140	
E Input to Any Output		5	200	400	ns
		10	85	170	
		15	65	130	
Transition Time t _{THL} , t _{TLH}		5	100	200	ns
		10	50	100	
		15	40	80	
Input Capacitance C _{IN}	Any Input		5	7,5	pF

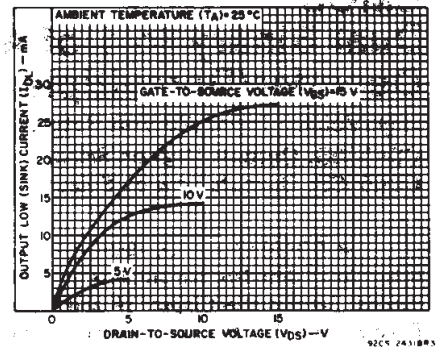

Fig. 1 — Typical output low (sink) current characteristics.

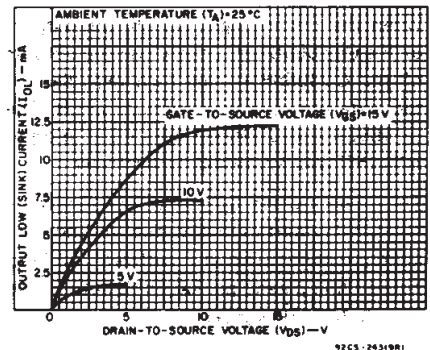

Fig. 2 — Minimum output low (sink) current characteristics.

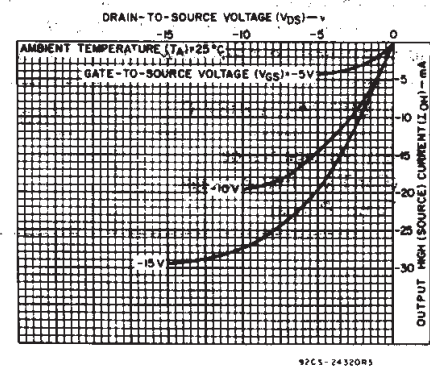

Fig. 3 — Typical output high (source) current characteristics.

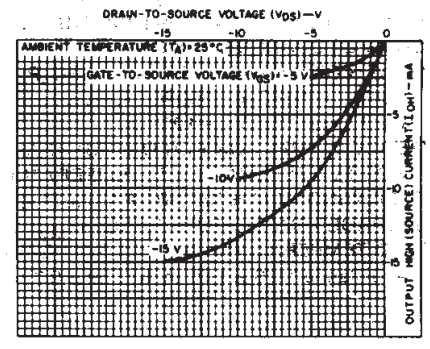

Fig. 4 — Minimum output high (source) current characteristics.

CD4555B, CD4556B Types

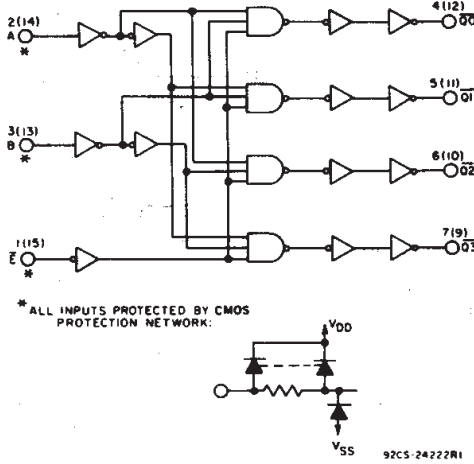

Fig. 5 - CD4556B logic diagram (1 of 2 identical circuits).

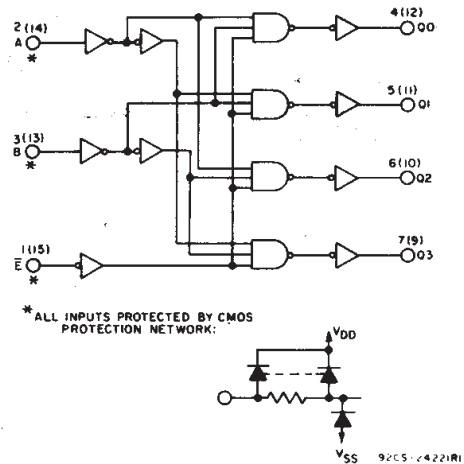

Fig. 6 - CD4555B logic diagram (1 of 2 identical circuits).

TRUTH TABLE

INPUTS		OUTPUTS CD4555B				OUTPUTS CD4556B			
ENABLE	SELECT	Q3	Q2	Q1	Q0	Q3	Q2	Q1	Q0
\bar{E}	B A	Q3	Q2	Q1	Q0	$\bar{Q}3$	$\bar{Q}2$	$\bar{Q}1$	$\bar{Q}0$
0	0 0	0	0	0	1	1	1	1	0
0	0 1	0	0	1	0	1	1	0	1
0	1 0	0	1	0	0	1	0	1	1
0	1 1	1	0	0	0	0	1	1	1
1	X X	0	0	0	0	1	1	1	1

X = DON'T CARE

LOGIC 1 \equiv HIGH
LOGIC 0 \equiv LOW

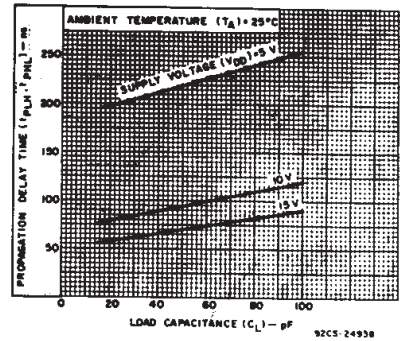

Fig. 7 - Typical propagation delay time vs. load capacitance (A or B input to any output).

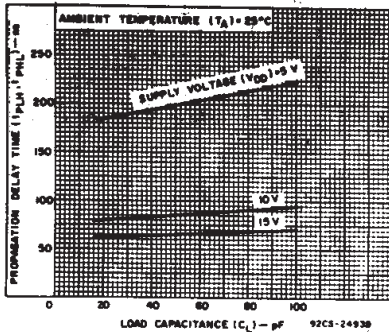

Fig. 8 - Typical propagation delay time vs. load capacitance (E input to any output).

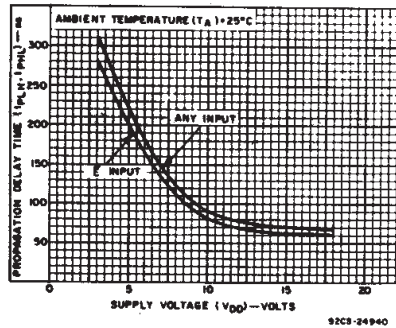

Fig. 9 - Typical propagation delay time vs. supply voltage.

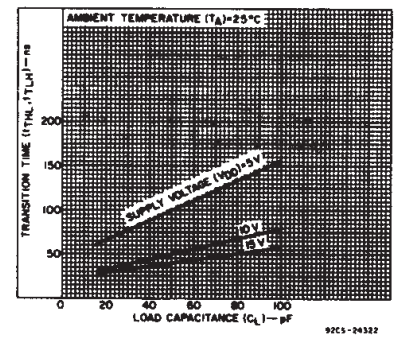

Fig. 10 - Typical transition time vs. load capacitance.

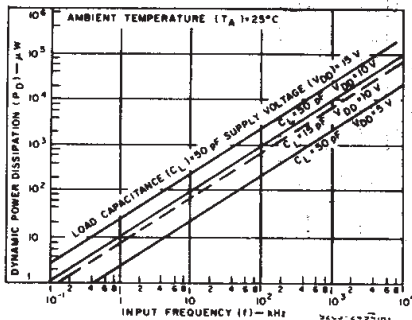

Fig. 11 - Typical dynamic power dissipation vs. frequency.

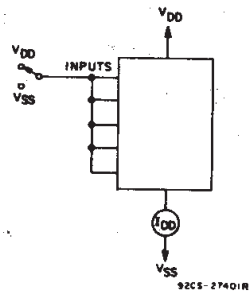

Fig. 12 - Quiescent device current test circuit.

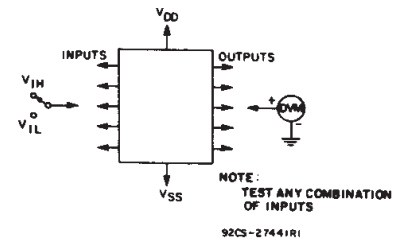

Fig. 13 - Input voltage test circuit.

3
COMMERCIAL CMOS
HIGH VOLTAGE ICs

CD4555B, CD4556B Types

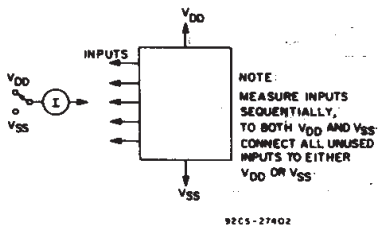

Fig. 14 - Input current test circuit.

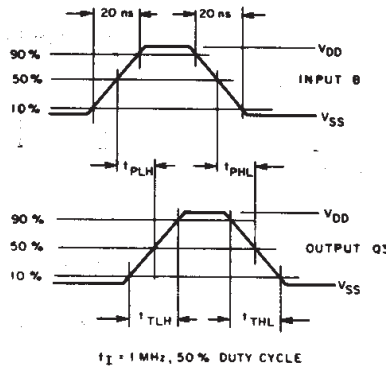

Fig. 15 - CD4555B B input to Q3 output dynamic signal waveforms.

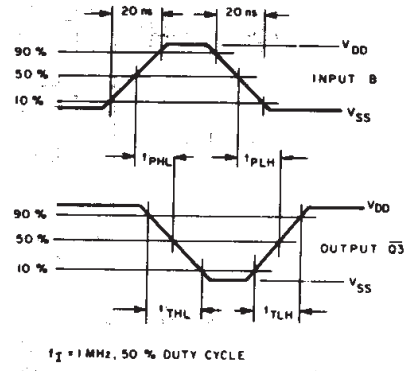

Fig. 16 - CD4556B B input to Q3 output dynamic signal waveforms.

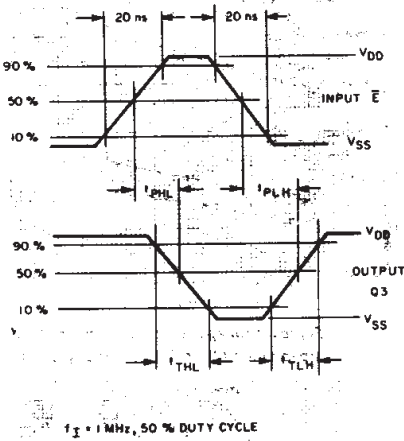

Fig. 17 - CD4555B E-bar input to Q3 output dynamic signal waveforms.

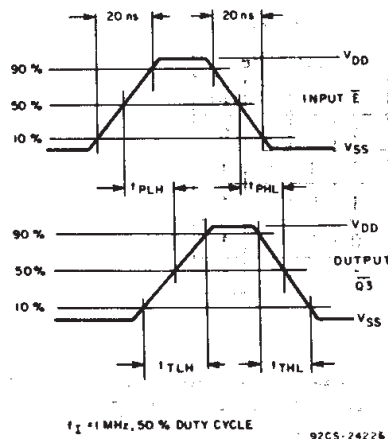
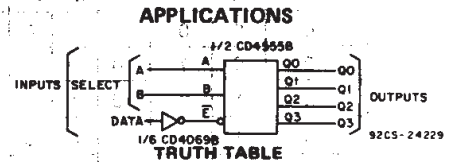

Fig. 18 - CD4556B E-bar input to Q3 output dynamic signal waveforms.



TRUTH TABLE

SELECT INPUTS		OUTPUTS			
B	A	Q0	Q1	Q2	Q3
0	0	DATA	0	0	0
0	1	0	DATA	0	0
1	0	0	0	DATA	0
1	1	0	0	0	DATA

Fig. 19 - 1-of-4 line data demultiplexer using CD4555B.

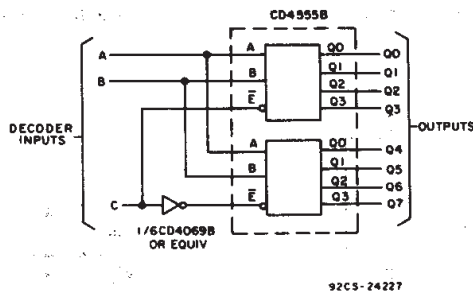

Fig. 20 - 1-of-8 decoder using CD4555B.

TRUTH TABLE

INPUTS			Q OUTPUTS							
C	B	A	0	1	2	3	4	5	6	7
0	0	0	1	0	0	0	0	0	0	0
0	0	1	0	1	0	0	0	0	0	0
0	1	0	0	0	1	0	0	0	0	0
0	1	1	0	0	0	1	0	0	0	0
1	0	0	0	0	0	0	1	0	0	0
1	0	1	0	0	0	0	0	1	0	0
1	1	0	0	0	0	0	0	0	1	0
1	1	1	0	0	0	0	0	0	0	1

CD4555B, CD4556B Types

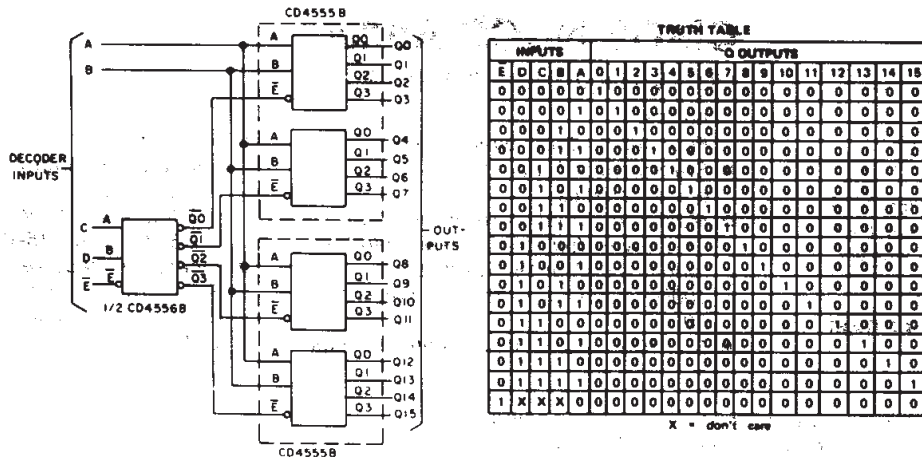
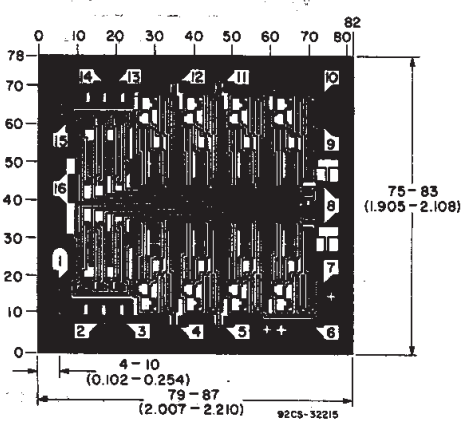
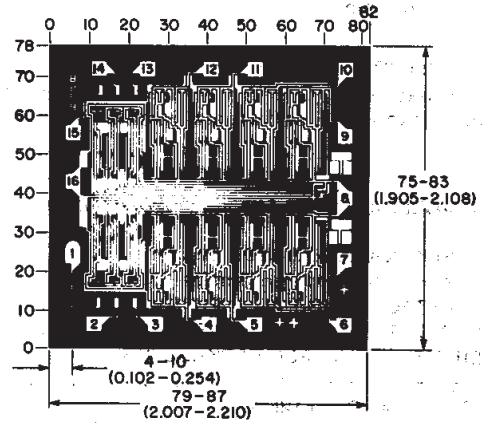

Fig. 21 - 1-of-16 decoder using CD4555B and CD4556B.



DIMENSIONS AND PAD LAYOUT FOR CD4555BH.



DIMENSIONS AND PAD LAYOUT FOR CD4556BH.

Dimensions in parentheses are in millimeters and are derived from the basic inch dimensions as indicated. Grid graduations are in mils (10⁻³ inch).

COMMERCIAL CMOS HIGH VOLTAGE ICs

PACKAGING INFORMATION

Orderable Device	Status ⁽¹⁾	Package Type	Package Drawing	Pins	Package Qty	Eco Plan ⁽²⁾	Lead/Ball Finish	MSL Peak Temp ⁽³⁾
7704701EA	ACTIVE	CDIP	J	16	1	None	Call TI	Level-NC-NC-NC
7704801EA	ACTIVE	CDIP	J	16	1	None	Call TI	Level-NC-NC-NC
CD4555BE	ACTIVE	PDIP	N	16	25	Pb-Free (RoHS)	CU NIPDAU	Level-NC-NC-NC
CD4555BF3A	ACTIVE	CDIP	J	16	1	None	Call TI	Level-NC-NC-NC
CD4555BM	ACTIVE	SOIC	D	16	40	Pb-Free (RoHS)	CU NIPDAU	Level-2-260C-1 YEAR/ Level-1-235C-UNLIM
CD4555BM96	ACTIVE	SOIC	D	16	2500	Pb-Free (RoHS)	CU NIPDAU	Level-2-260C-1 YEAR/ Level-1-235C-UNLIM
CD4555BMT	ACTIVE	SOIC	D	16	250	Pb-Free (RoHS)	CU NIPDAU	Level-2-260C-1 YEAR/ Level-1-235C-UNLIM
CD4555BNSR	ACTIVE	SO	NS	16	2000	Pb-Free (RoHS)	CU NIPDAU	Level-2-260C-1 YEAR/ Level-1-235C-UNLIM
CD4555BPW	ACTIVE	TSSOP	PW	16	90	Pb-Free (RoHS)	CU NIPDAU	Level-1-250C-UNLIM
CD4555BPWR	ACTIVE	TSSOP	PW	16	2000	Pb-Free (RoHS)	CU NIPDAU	Level-1-250C-UNLIM
CD4556BE	ACTIVE	PDIP	N	16	25	Pb-Free (RoHS)	CU NIPDAU	Level-NC-NC-NC
CD4556BF	ACTIVE	CDIP	J	16	1	None	Call TI	Level-NC-NC-NC
CD4556BF3A	ACTIVE	CDIP	J	16	1	None	Call TI	Level-NC-NC-NC
CD4556BM	ACTIVE	SOIC	D	16	40	Pb-Free (RoHS)	CU NIPDAU	Level-2-260C-1 YEAR/ Level-1-235C-UNLIM
CD4556BM96	ACTIVE	SOIC	D	16	2500	Pb-Free (RoHS)	CU NIPDAU	Level-2-260C-1 YEAR/ Level-1-235C-UNLIM
CD4556BMT	ACTIVE	SOIC	D	16	250	Pb-Free (RoHS)	CU NIPDAU	Level-2-260C-1 YEAR/ Level-1-235C-UNLIM

⁽¹⁾ The marketing status values are defined as follows:

ACTIVE: Product device recommended for new designs.

LIFEBUY: TI has announced that the device will be discontinued, and a lifetime-buy period is in effect.

NRND: Not recommended for new designs. Device is in production to support existing customers, but TI does not recommend using this part in a new design.

PREVIEW: Device has been announced but is not in production. Samples may or may not be available.

OBSOLETE: TI has discontinued the production of the device.

⁽²⁾ Eco Plan - May not be currently available - please check <http://www.ti.com/productcontent> for the latest availability information and additional product content details.

None: Not yet available Lead (Pb-Free).

Pb-Free (RoHS): TI's terms "Lead-Free" or "Pb-Free" mean semiconductor products that are compatible with the current RoHS requirements for all 6 substances, including the requirement that lead not exceed 0.1% by weight in homogeneous materials. Where designed to be soldered at high temperatures, TI Pb-Free products are suitable for use in specified lead-free processes.

Green (RoHS & no Sb/Br): TI defines "Green" to mean "Pb-Free" and in addition, uses package materials that do not contain halogens, including bromine (Br) or antimony (Sb) above 0.1% of total product weight.

⁽³⁾ MSL, Peak Temp. -- The Moisture Sensitivity Level rating according to the JEDEC industry standard classifications, and peak solder temperature.

Important Information and Disclaimer: The information provided on this page represents TI's knowledge and belief as of the date that it is provided. TI bases its knowledge and belief on information provided by third parties, and makes no representation or warranty as to the accuracy of such information. Efforts are underway to better integrate information from third parties. TI has taken and continues to take reasonable steps to provide representative and accurate information but may not have conducted destructive testing or chemical analysis on

incoming materials and chemicals. TI and TI suppliers consider certain information to be proprietary, and thus CAS numbers and other limited information may not be available for release.

In no event shall TI's liability arising out of such information exceed the total purchase price of the TI part(s) at issue in this document sold by TI to Customer on an annual basis.

J (R-GDIP-T**)

14 LEADS SHOWN

CERAMIC DUAL IN-LINE PACKAGE



DIM \ PINS **	14	16	18	20
A	0.300 (7,62) BSC	0.300 (7,62) BSC	0.300 (7,62) BSC	0.300 (7,62) BSC
B MAX	0.785 (19,94)	.840 (21,34)	0.960 (24,38)	1.060 (26,92)
B MIN	—	—	—	—
C MAX	0.300 (7,62)	0.300 (7,62)	0.310 (7,87)	0.300 (7,62)
C MIN	0.245 (6,22)	0.245 (6,22)	0.220 (5,59)	0.245 (6,22)



4040083/F 03/03

- NOTES:
- All linear dimensions are in inches (millimeters).
 - This drawing is subject to change without notice.
 - This package is hermetically sealed with a ceramic lid using glass frit.
 - Index point is provided on cap for terminal identification only on press ceramic glass frit seal only.
 - Falls within MIL STD 1835 GDIP1-T14, GDIP1-T16, GDIP1-T18 and GDIP1-T20.

N (R-PDIP-T**)

PLASTIC DUAL-IN-LINE PACKAGE

16 PINS SHOWN



- NOTES:
- A. All linear dimensions are in inches (millimeters).
 - B. This drawing is subject to change without notice.
 - C Falls within JEDEC MS-001, except 18 and 20 pin minimum body length (Dim A).
 - D The 20 pin end lead shoulder width is a vendor option, either half or full width.

4040049/E 12/2002

D (R-PDSO-G16)

PLASTIC SMALL-OUTLINE PACKAGE



- NOTES:
- A. All linear dimensions are in inches (millimeters).
 - B. This drawing is subject to change without notice.
 - C. Body dimensions do not include mold flash or protrusion not to exceed 0.006 (0,15).
 - D. Falls within JEDEC MS-012 variation AC.

MECHANICAL DATA

NS (R-PDSO-G**)

PLASTIC SMALL-OUTLINE PACKAGE

14-PINS SHOWN



- NOTES:
- A. All linear dimensions are in millimeters.
 - B. This drawing is subject to change without notice.
 - C. Body dimensions do not include mold flash or protrusion, not to exceed 0,15.

PW (R-PDSO-G**)

PLASTIC SMALL-OUTLINE PACKAGE

14 PINS SHOWN



4040064/F 01/97

- NOTES: A. All linear dimensions are in millimeters.
 B. This drawing is subject to change without notice.
 C. Body dimensions do not include mold flash or protrusion not to exceed 0,15.
 D. Falls within JEDEC MO-153

IMPORTANT NOTICE

Texas Instruments Incorporated and its subsidiaries (TI) reserve the right to make corrections, modifications, enhancements, improvements, and other changes to its products and services at any time and to discontinue any product or service without notice. Customers should obtain the latest relevant information before placing orders and should verify that such information is current and complete. All products are sold subject to TI's terms and conditions of sale supplied at the time of order acknowledgment.

TI warrants performance of its hardware products to the specifications applicable at the time of sale in accordance with TI's standard warranty. Testing and other quality control techniques are used to the extent TI deems necessary to support this warranty. Except where mandated by government requirements, testing of all parameters of each product is not necessarily performed.

TI assumes no liability for applications assistance or customer product design. Customers are responsible for their products and applications using TI components. To minimize the risks associated with customer products and applications, customers should provide adequate design and operating safeguards.

TI does not warrant or represent that any license, either express or implied, is granted under any TI patent right, copyright, mask work right, or other TI intellectual property right relating to any combination, machine, or process in which TI products or services are used. Information published by TI regarding third-party products or services does not constitute a license from TI to use such products or services or a warranty or endorsement thereof. Use of such information may require a license from a third party under the patents or other intellectual property of the third party, or a license from TI under the patents or other intellectual property of TI.

Reproduction of information in TI data books or data sheets is permissible only if reproduction is without alteration and is accompanied by all associated warranties, conditions, limitations, and notices. Reproduction of this information with alteration is an unfair and deceptive business practice. TI is not responsible or liable for such altered documentation.

Resale of TI products or services with statements different from or beyond the parameters stated by TI for that product or service voids all express and any implied warranties for the associated TI product or service and is an unfair and deceptive business practice. TI is not responsible or liable for any such statements.

Following are URLs where you can obtain information on other Texas Instruments products and application solutions:

Products		Applications	
Amplifiers	amplifier.ti.com	Audio	www.ti.com/audio
Data Converters	dataconverter.ti.com	Automotive	www.ti.com/automotive
DSP	dsp.ti.com	Broadband	www.ti.com/broadband
Interface	interface.ti.com	Digital Control	www.ti.com/digitalcontrol
Logic	logic.ti.com	Military	www.ti.com/military
Power Mgmt	power.ti.com	Optical Networking	www.ti.com/opticalnetwork
Microcontrollers	microcontroller.ti.com	Security	www.ti.com/security
		Telephony	www.ti.com/telephony
		Video & Imaging	www.ti.com/video
		Wireless	www.ti.com/wireless

Mailing Address: Texas Instruments
Post Office Box 655303 Dallas, Texas 75265